

AC

DC

**Switch - disconnectors  
and changeover switches  
general catalogue**

# Presentation

TELERGON is a market leader in the design and manufacture of electromechanical products, providing solutions for the isolation and protection of low voltage electrical equipment.

Experience, knowledge, and innovation are the values of our talented team, providing a strong reputation for the products manufactured by TELERGON.

The various ranges of TELERGON switch disconnectors and changeover switches have numerous applications in the field of electrical engineering, including a range of product designed specifically for renewable energy applications.



[www.telergon.com](http://www.telergon.com)



# About the catalog

This catalog is organized in a way that you can choose and get quickly and easily all the product information required.

At the beginning (pages 2-3) you will find a complete overview of the range offered, classified by series over its full range of amperages, with an index that will take you to the page of presentation which corresponds, to a general guide for quick selection and to the page where you will find gathered all the information of the selected product.

## 1 Index & overview of all series

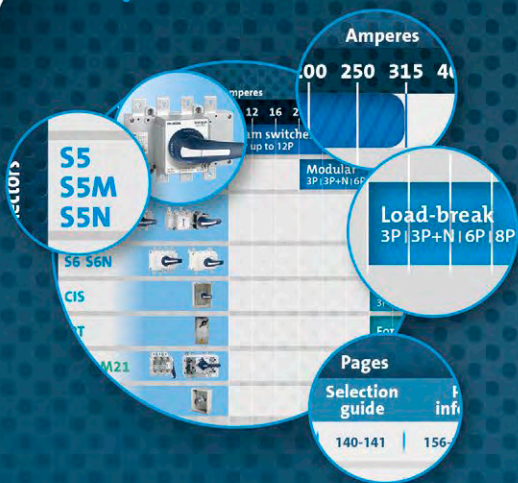

## 2 General information of the product range



## 3 Quick selection guide by series & index



## 4 Full information of selected product

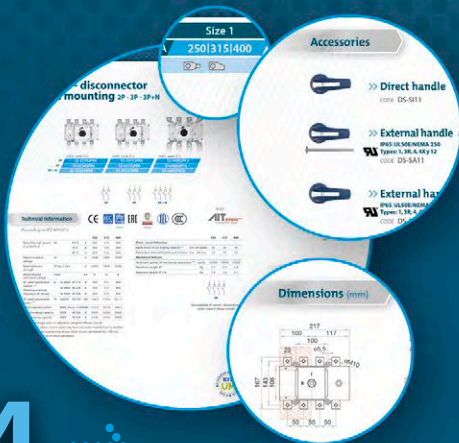

This catalogue is printed on paper coming from sustainable certified forestry

INDEX OVERVIEW  
OF THE RANGE

Amperes

10 12 16 20 25 32 40 50 63 80 100 125 160 200 250 315 400 500

		10	12	16	20	25	32	40	50	63	80	100	125	160	200	250	315	400	500
AC	Switch - disconnectors	T TB TF TP	Cam switches 1P up to 12P																Under request, please consult
	ZBK	Modular 3P   3P+N   6P   8P																	
	S5 S5M S5N	Load-break 2P   3P   3P+N   6P   8P																	
	S6 S6N	Load-break 2P   3P   3P+N   6P   8P																	
	CIS	Enclosed load-break 3P   3P+N																	
	IPT	For transformer secondary protection																	
	M11   M21	With fuses 2P   3P   3P+N																	
CIF	Enclosed with fuses 3P   3P+N																		
AC	Changeover switches	T TB TF TP	Cam switches 1P up to 4P																Under request, please consult
	ZBK	Modular 3P   3P+N																	
	CEC	Compact 3P   3P+N																	
	S5F	Back to back or line arrangement 3P   3P+N																	
	CCF CCP	Compact load-break 3P   3P+N																	
	S5B	By-pass load-break 3P   3P+N																	
	CTR	Enclosed load-break 3P   3P+N																	
UM	Motorized Unit Kit	For switch - disconnector																	
DC	Switch - disconnectors	ZFC ZFV	Modular up to 1500 Vdc																
	S5 DC S5M DC S5N DC	Load-break & multi-string up to 1500 Vdc																	
	S6 DC S6N DC S6R DC	Load-break up to 1500 Vdc																	
DC	Disconnectors	S5 DC S6 DC	Isolation only 1500 Vdc																

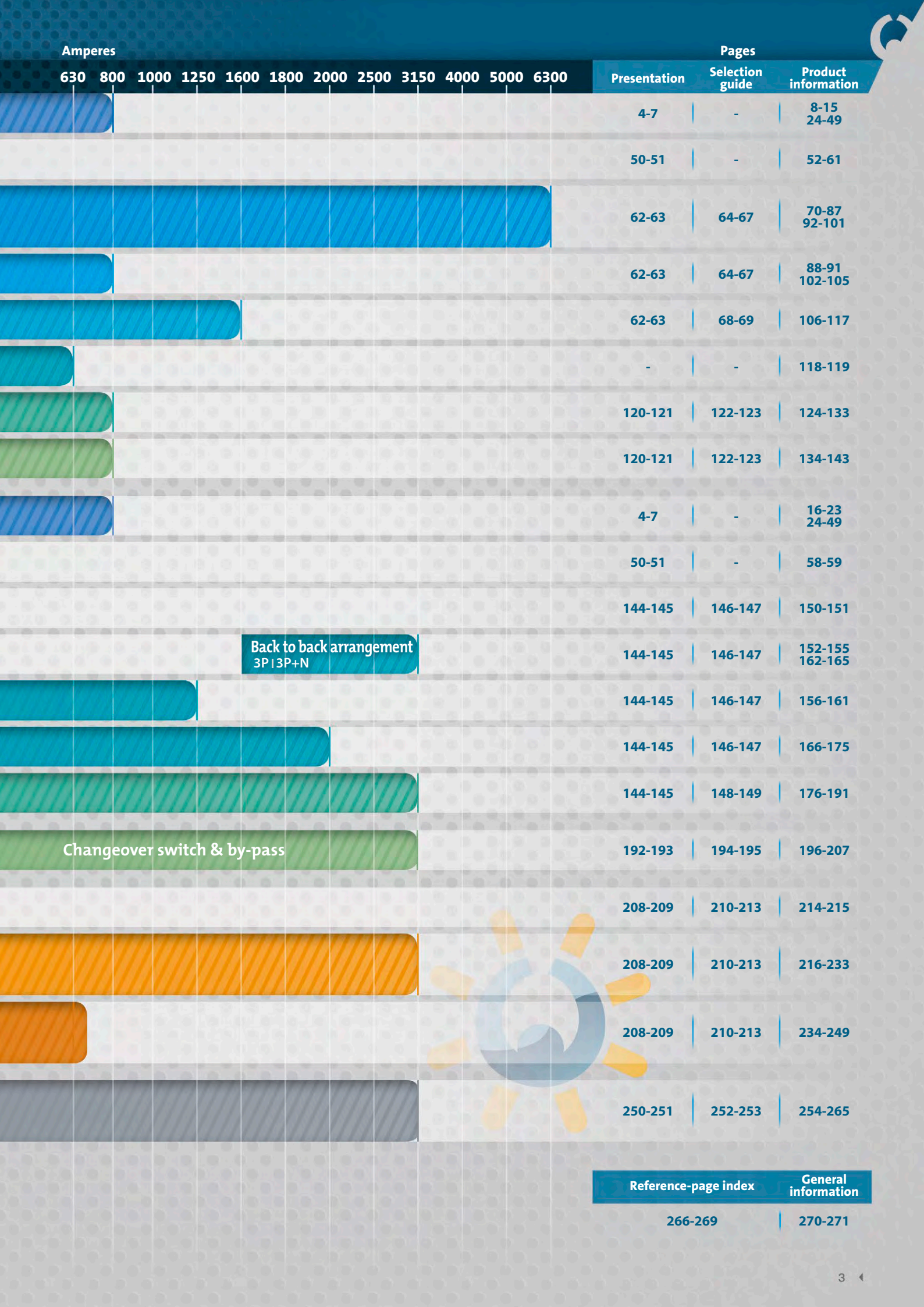

Amperes

630 800 1000 1250 1600 1800 2000 2500 3150 4000 5000 6300

Pages

Presentation

Selection guide

Product information

	4-7	-	8-15 24-49
	50-51	-	52-61
	62-63	64-67	70-87 92-101
	62-63	64-67	88-91 102-105
	62-63	68-69	106-117
	-	-	118-119
	120-121	122-123	124-133
	120-121	122-123	134-143
	4-7	-	16-23 24-49
	50-51	-	58-59
	144-145	146-147	150-151
Back to back arrangement 3P 3P+N	144-145	146-147	152-155 162-165
	144-145	146-147	156-161
	144-145	146-147	166-175
	144-145	148-149	176-191
Changeover switch & by-pass	192-193	194-195	196-207
	208-209	210-213	214-215
	208-209	210-213	216-233
	208-209	210-213	234-249
	250-251	252-253	254-265

Reference-page index

General information

266-269

270-271

# Cam switches

Cam switches available in different construction models over a wide current range with a large variety of accessories.



Cam switches are manufactured in different series under strict quality controls to provide a reliable product that meets the most demanding requirements.

They consist of chambers, each containing up to two double break contacts of positive opening. These contacts silver alloy plated providing a long electromechanical life.

In sizes 0 - 1 and 2, the terminals are equipped with captive clamp screws to facilitate installation work, and all the connections themselves are covered to provide an IP20 protection rating.

The different configurations of contacts available provide flexible, faster and safer solutions for several electrical operations at a highly competitive cost.

## Range codification:

### Standard products

They are listed in this section and are encoded according to the 16-digit bar logic explained below. This descriptive method will be used on all pages in the cam switches range for your convenience and better understanding.

### Special products

They are made according to customer specifications or to comply with a diagram or special scheme. In these cases, the code is formed by the corresponding series (T-TB-TF-TP), the amperage and an order number assigned to the scheme (see blank diagrams form on page 33).

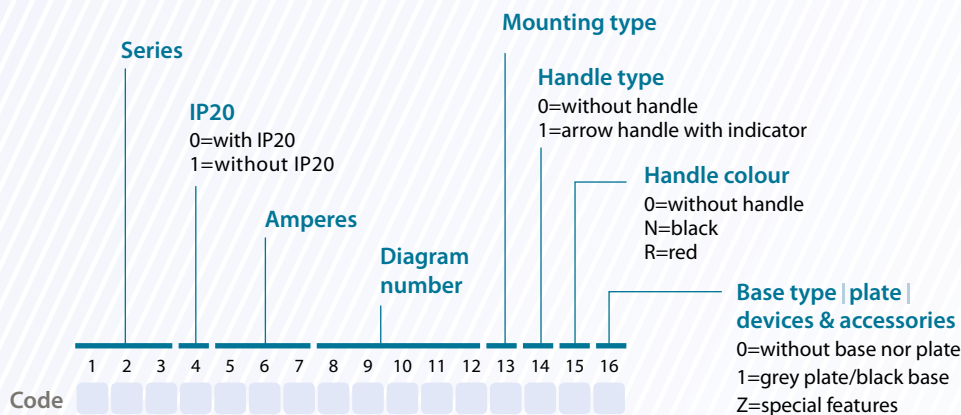

Example: 1 2 3 4 5 6 7 8 9 10 11 12 13 14 15 16  
**T-0010000012E1N1**

T series | 100 amperes | 012 diagram | E fixing |  
Standard handle | Black colour |  
Grey plate/black base |

According to:

IEC 60947-3



UL508 - CAN/CSA C22.2 N° 14

RoHS

Testing and approvals:



series  
**T**



1 2 3 4 5 6  
T -

Wide range of sizes and ratings.

Supplied with IP20 removable terminals protection on sizes 0 - 1 - 2 (except T175).

Wide range of devices and accessories.

series  
**TB**



1 2 3 4 5 6  
TB -

Side access to all terminal screws (up and down).

Two different bodies depending on mounting type: door or base mounting.

Wide range of devices and accessories.

series  
**TF**



1 2 3 4 5 6  
TF -

Square body, smooth sides, axial access to terminal screws.

Two different bodies depending on mounting type: door or base mounting.

Wide range of devices and accessories.

series  
**TP**



1 2 3 4 5 6  
TP -

Reduce-sized body. Door mounting only.

Wide range of devices and accessories.

series | type  
**TIP**



Serie T  
1 2 3 4 5 6  
C I T P

- > Cam switch in plastic enclosure for gland entry.
- > From 12 up to 40 A.
- > Padlockable handle under request.

series | type  
**T-TFIR**



Serie T Serie TF  
1 2 3 4 5 1 2 3 4 5  
C I T R C T F R

- > Cam switch in plastic enclosure for gland entry.
- > From 25 up to 100 A.
- > Padlockable handle under request.

series | type  
**T-TBIA-C**



Serie T Serie TB  
1 2 3 4 5 1 2 3 4 5  
C I T A C T B A  
1 2 3 4 5 1 2 3 4 5  
C I T C C T B C

- > Cam switch in metal enclosure of cast aluminium
  - <sup>4</sup>A From 12 up to 63 A.
- > In sheet steel enclosure
  - <sup>4</sup>C From 100 A upwards.
- > Gland entry.
- > Several enclosure sizes.
- > Padlockable handle under request.

>> Ask for more information about these applications with enclosure.

# TP | T | TB | TF

## Fixing with screws | E type

For T - TB - TF - TP series

- > Frontal fixing plate for 4 screws, reversible mounting plate in T series (except T175 and size 3).
- > Door mounting with arrow handle, indicating plate, escutcheon and fixing plate IP65.

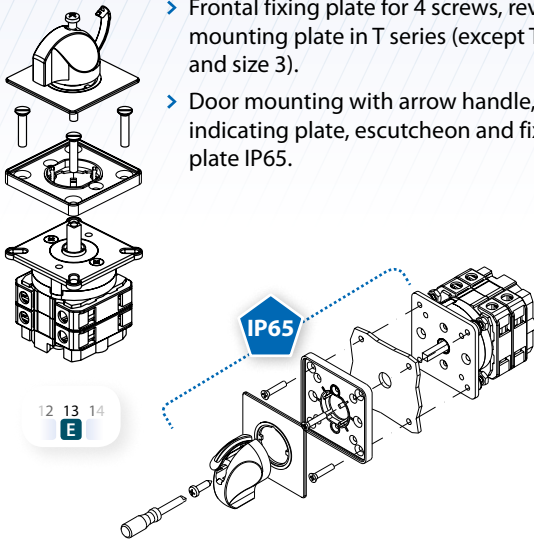

## Central quick fixing $\varnothing 22$ | C type

For T - TB - TF series

- > Door mounting for  $\varnothing 22$  mm available for sizes 0 and 1.
- > For arrow handle with indicator or padlockable handle.
- > Maximum number of chambers supported  
Size 0 = 6  
Size 1 = 4

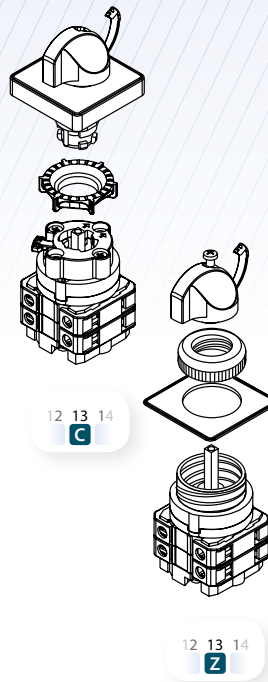

## Central fixing with metal nut $\varnothing 22$ | Z type

For T - TF series

- > Door mounting for metal nut  $\varnothing 22$  mm available for sizes 0 and 1.  
(also  $\varnothing 30$  mm under request).

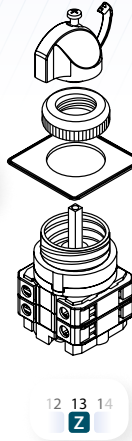

## Base mounting by screws with direct handle | D type Base mounting by screws without plate nor handle | G type

For T series

- > Rear fixing plate for 4 screws, reversible mounting plate in T series (except T175 and size 3).

For TB - TF series

- > Fixed rear support plate as standard.
- > Serie TB for 4 screws.
- > Serie TF for two screws (also DIN rail).

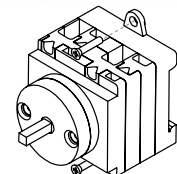
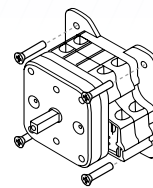
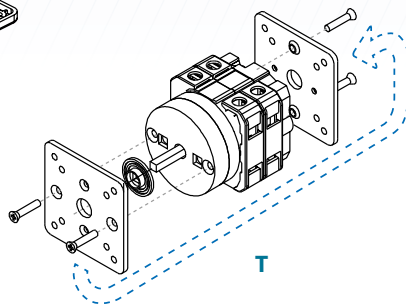
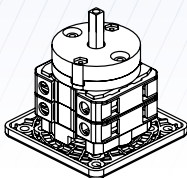
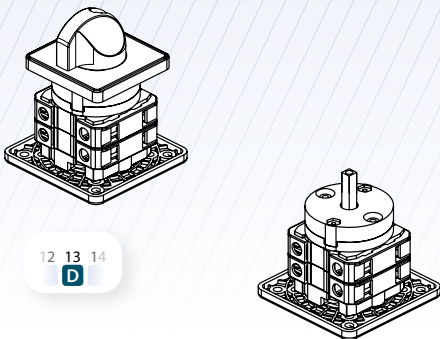

## Base mounting with clutch device and door handle | F type

For T - TB - TF series

- > Rear fixing plate for 4 screws in T - TB series or two screws and DIN rail in TF series.
- > With clutch device and door lock, according to series and sizes.
- > The clutch device (D501) for size 0, if it is combined with other accessory, must be size 1.
- > The clutch device (D501) and shaft extension are supplied separately (as accessories) or incorporated with the cam switch (size 3 is always incorporated with the cam switch).
- > Specify useful depth of the space available when ordering.

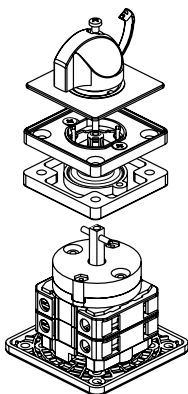

## Door mounting

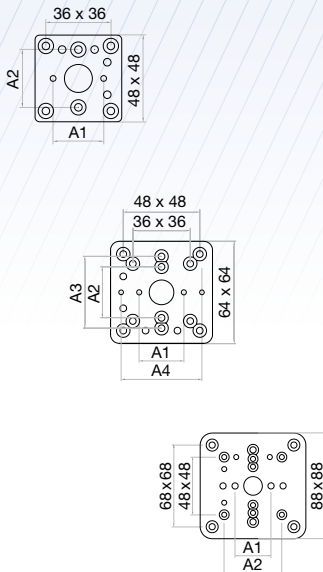

Size	Models		13
0	A1 = 28 mm	A2 = 32 mm	M
	A1 = 30 mm	A2 = 34 mm	N
	A1 = 35 mm	A2 = 38 mm	O
1	A1 = 28 mm A4 = 46 mm	A2 = 32 mm	M
	A1 = 33 mm A3 = 47 mm	A2 = 30 mm A4 = 50 mm	N
	A1 = 32 mm A3 = 45 mm	A2 = 32 mm A4 = 45 mm	P
	A1 = 38 mm	A3 = 40 mm	M
2	A1 = 30 mm	A2 = 50 mm	P

### Multi-distance fixing plates with screws

For T - TB - TF series

- > Multidrill plates for different fixing distances.
- > Fixing with two screws for mounting without base nor indicating plate.
- > Available for sizes 0 - 1 - 2. (size 0 also supports multi-fixing plate size 1).

## Base mounting

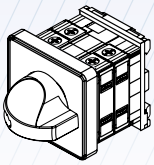

12 13 14  
A

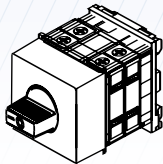

12 13 14 15 16  
H 8 N O

### DIN rail mounting with direct handle | A type

For T series

- > Rear fixing support (D904) for T series sizes 0 and 1.
- > DIN rail is included in TF series.

### DIN rail mounting with modular handle | H type

For TF series

- > Rear fixing support and modular handle tape (D905) for T - TF series size 0.

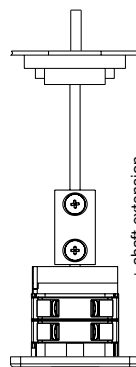
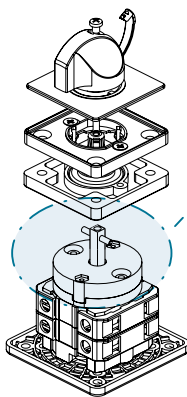

Size 0

Clutch device with door interlock

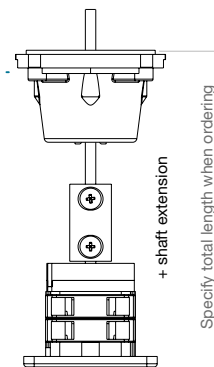

Sizes 0 - 1 - 2 - 3

# TP | T | TB | TF

## Door mounting switch

### 1P up to 12P

Size 0

A 10|12|16|20|25|32



### Technical information



consult

consult

consult

consult

According to IEC 60947-3

UL508 - CAN/CSA C22.2 N° 14

According to IEC 60947-3			TP10	T12	T20	TB20	TB25	TB32	TF12	TF16	TF25	
Rated thermal current	I <sub>th</sub>	A	12	16	25	20	25	32	20	25	32	
Rated insulation voltage	U <sub>i</sub>	V	500	500	500	500	500	500	690	690	690	
Rated impulse withstand voltage	U <sub>imp</sub>	kV	4	6	6	4	4	4	6	6	6	
AC rated operational current	I <sub>e</sub>	U <sub>e</sub> 415V AC13A	A	10	-	-	-	-	-	-	-	
		U <sub>e</sub> 415V AC21A	A	12	16	25	20	25	32	20	25	32
		U <sub>e</sub> 415V AC22A	A	12	16	25	20	25	32	20	25	32
		U <sub>e</sub> 415V AC23A	A	10	10	25	20	25	32	8	16	20
Rated conditional short-circuit current		kA	5	10	10	5	5	5	5	5	5	
Rated maximum current	g <sub>L</sub> -g <sub>G</sub>	A	16	25	25	35	35	35	20	25	32	
Rated breaking capacity	400V; cos φ=0,45	A	80	80	100	160	200	256	100	160	200	
Rated short-time withstand current (1 sec)		A	100	240	400	240	400	500	350	400	500	
Mechanical durability (according to the standards, for other values please consult)			1000	10000	10000	10000	10000	10000	10000	10000	10000	
Rigid copper conductor		mm <sup>2</sup>	2x4	2x4	2x4	1x10 2x6	1x10 2x6	1x10 2x6	1x10	1x10	1x10	
Flexible copper conductor		mm <sup>2</sup>	2x2,5	2x2,5	2x2,5	1x6 2x4	1x6 2x4	1x6 2x4	1x6	1x6	1x6	
According to UL508 - CAN / CSA C22.2 N° 14			T12	T20				TF12	TF16	TF25		
Rated thermal current	I <sub>th</sub>	A	-	12	20	-	-	-	16	20	25	
General use rating		Vac	-	300	300	-	-	-	600	600	600	
	3x240V	HP	-	2	5	-	-	-	2	5	7,5	
	3x480V	HP	-	-	-	-	-	-	5	10	12	
AC rated operational power	3x600V	HP	-	-	-	-	-	-	5	10	15	

#### Normal service conditions:

Ambient air temperature (°C): -5°...+40°. Maximum altitude: 2.000 m. Maximum humidity: 90%. Pollution degree: 3 (standard for industrial applications). Rated frequency at AC utilization categories: 50/60 Hz.

Rated duties at utilization categories AC21A, AC22A and AC23A: Continuing (8 hours); uninterrupted.

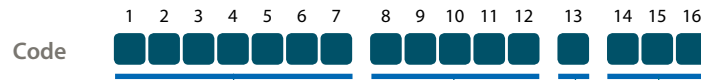

Series | Amp

- TP-0010
- T-00012
- T-00020
- TB-0020
- TB-0025
- TB-0032
- TF-0012
- TF-0016
- TF-0025

Diagram

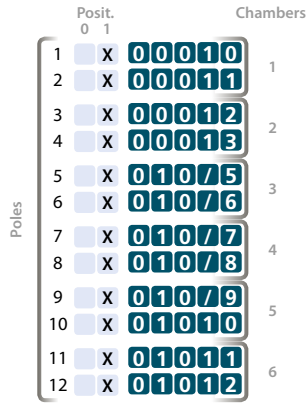

Type

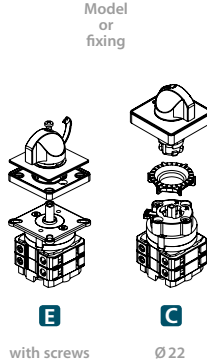
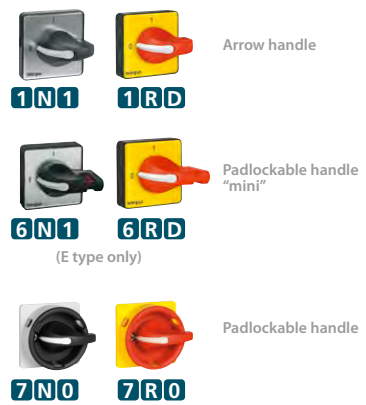
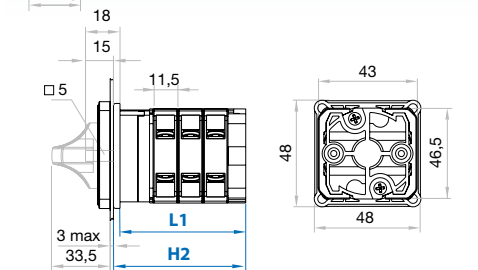
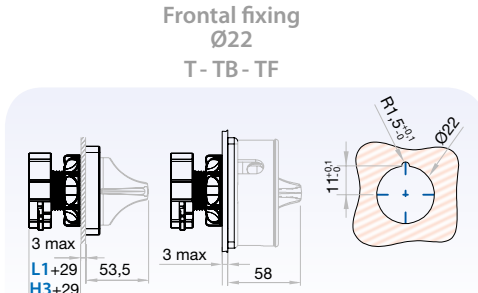
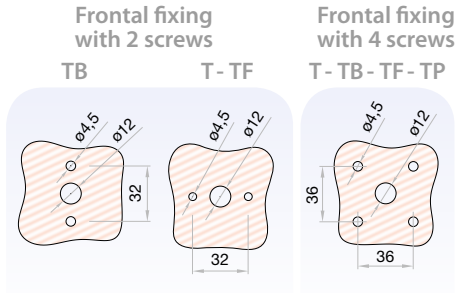
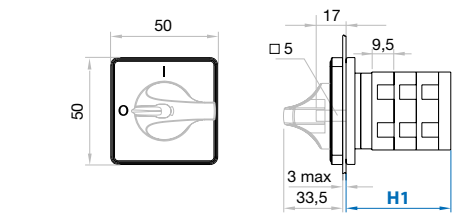
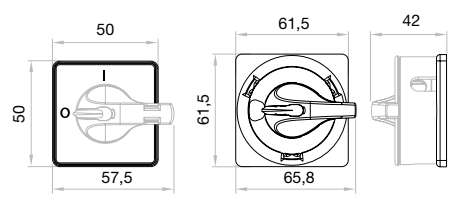

Plate and handle



Dimensions (mm)



TP series	Chambers	1	2	3	4	5	6
H1		26,8	36,3	45,8	55,3	64,8	74,3

T series	Chambers	1	2	3	4	5	6
L1		34,5	46	57,5	69	80,5	92
H2		37,5	49	60,5	72	83,5	95

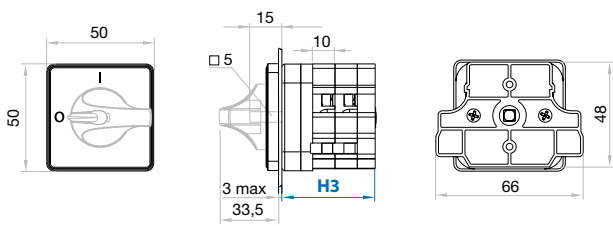

TB series	Chambers	1	2	3	4	5	6
H3		31,5	41,5	51,5	61,5	71,5	81,5

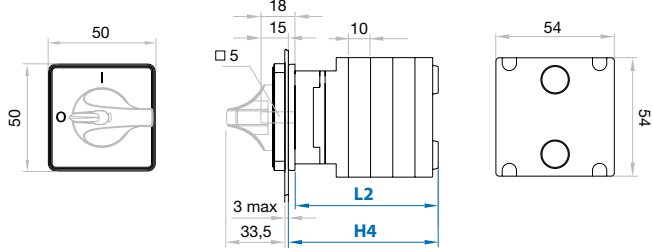

TF series	Chambers	1	2	3	4	5	6
L2		45	55	65	75	85	95
H4		48	58	68	78	88	98

# T

## Door mounting switch

### 1P up to 12P

Size 1

A 16|25|32|40



T

### Technical information



consult

consult

According to IEC 60947-3  
UL508 - CAN/CSA C22.2 N° 14

According to IEC 60947-3			T16	T25	T32	T40	
Rated thermal current	I <sub>th</sub>	A	25	32	40	50	
Rated insulation voltage	U <sub>i</sub>	V	690	690	690	690	
Rated impulse withstand voltage	U <sub>imp</sub>	kV	6	6	8	8	
AC rated operational current	I <sub>e</sub>	U <sub>e</sub> 415V AC21A	A	25	32	40	50
		U <sub>e</sub> 415V AC22A	A	25	32	40	50
		U <sub>e</sub> 415V AC23A	A	16	20	25	32
Rated conditional short-circuit current		kA	10	10	10	10	
Rated maximum current	gL-gG	A	32	32	50	50	
Rated breaking capacity	400V; cos φ=0,45	A	160	200	256	320	
Rated short-time withstand current (1 sec)		A	500	650	800	800	
Mechanical durability (according to the standards, for other values please consult)			10000	10000	10000	10000	
Rigid copper conductor		mm <sup>2</sup>	2x6	2x6	2x10	2x10	
Flexible copper conductor		mm <sup>2</sup>	2x4	2x4	2x6	2x6	
According to UL508 - CAN / CSA C22.2 N° 14			T16	T25	T32	T40	
Rated thermal current	I <sub>th</sub>	A	16	25	32	40	
General use rating		Vac	600	600	600	600	
	3x240V	HP	5	7,5	10	15	
	3x480V	HP	10	15	20	25	
AC rated operational power	3x600V	HP	10	15	20	25	

#### Normal service conditions:

Ambient air temperature (°C): -5°...+40°. Maximum altitude: 2.000 m. Maximum humidity: 90%. Pollution degree: 3 (standard for industrial applications). Rated frequency at AC utilization categories: 50/60 Hz.

Rated duties at utilization categories AC21A, AC22A and AC23A: Continuing (8 hours); uninterrupted.

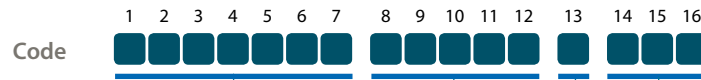

Series | Amp

T-00016
T-00025
T-00032
T-00040

Diagram

Posit.	0 1		Chambers
	0	1	
1	X	00010	1
2	X	00011	1
3	X	00012	2
4	X	00013	2
5	X	01075	3
6	X	01076	3
7	X	01077	4
8	X	01078	4
9	X	01079	5
10	X	01010	5
11	X	01011	6
12	X	01012	6

Type

Model or fixing

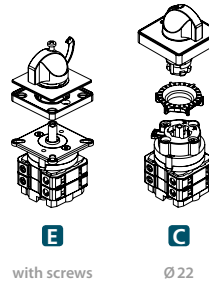
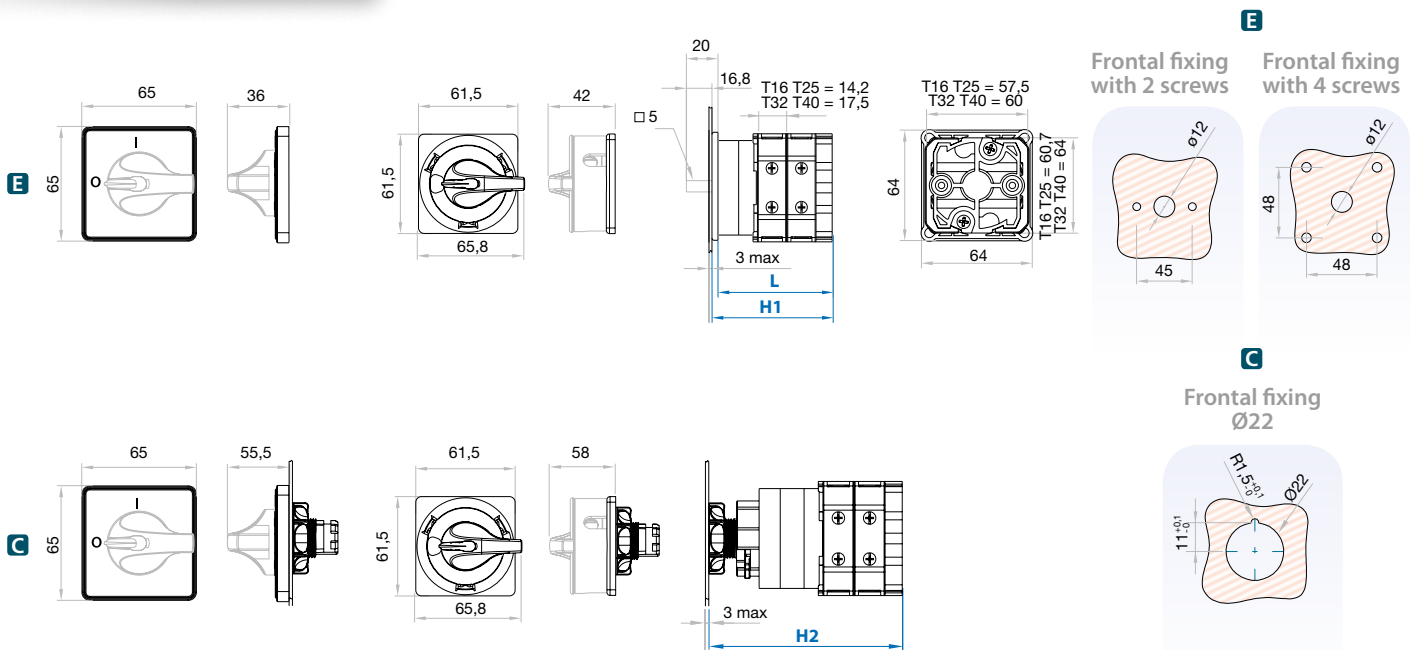

Plate and handle



Dimensions (mm)



T series	Chambers	1	2	3	4	5	6
T16 T25	L	46,4	60,6	74,8	89	103,2	117,4
	H1	49,6	63,8	78	92,2	106,4	120,6
	H2	75,5	89,5	103,7	117,9	132,1	146,3
T32 T40	L	49,8	67,3	84,8	102,3	119,8	137,3
	H1	53	70,5	88	105,5	123	140,5
	H2	78,8	96,3	113,8	131,3	148,8	166,3

# T

## Door mounting switch

### 1P up to 12P

Size 2

A 50|63|80|100|125|175



\* Except T175



T

### Technical information



consult

consult

consult

consult

According to IEC 60947-3  
UL508 - CAN/CSA C22.2 N° 14

According to IEC 60947-3			T50	T63	T80	T100	T125	T175	
Rated thermal current	I <sub>th</sub>	A	63	80	80	125	125	200	
Rated insulation voltage	U <sub>i</sub>	V	690	690	690	690	690	1000	
Rated impulse withstand voltage	U <sub>imp</sub>	kV	8	8	8	8	8	8	
AC rated operational current	I <sub>e</sub>	U <sub>e</sub> 415V AC21A	A	63	80	80	125	125	200
		U <sub>e</sub> 415V AC22A	A	63	80	80	115	115	200
		U <sub>e</sub> 415V AC23A	A	63	63	63	100	100	200
Rated conditional short-circuit current		kA	15	15	15	15	15	15 <sup>(2)</sup>	
Rated maximum current	g <sub>L</sub> -g <sub>G</sub>	A	80	80	80	125	125	160	
Rated breaking capacity	400V; cos φ=0,45	A	504	504	504	640	640	1600	
Rated short-time withstand current (1 sec)		A	1600	1600	1600	2500	2500	3500	
Mechanical durability (according to the standards, for other values please consult)			10000	10000	10000	8000	8000	8000	
Rigid copper conductor		mm <sup>2</sup>	16/25 <sup>(1)</sup>	16/25 <sup>(1)</sup>	16/25 <sup>(1)</sup>	35/50 <sup>(1)</sup>	35/50 <sup>(1)</sup>	95	
Flexible copper conductor		mm <sup>2</sup>	10/16 <sup>(1)</sup>	10/16 <sup>(1)</sup>	10/16 <sup>(1)</sup>	16/35 <sup>(1)</sup>	16/35 <sup>(1)</sup>	95	
According to UL508 - CAN / CSA C22.2 N° 14			T50	T63	T80	T100	T125	T175	
Rated thermal current	I <sub>th</sub>	A	63	63	63	100	100	200	
General use rating		Vac	600	600	600	600	600	600	
	3x240V	HP	20	20	20	30	30	25	
	3x480V	HP	40	40	40	50	50	60	
AC rated operational power	3x600V	HP	40	40	40	50	50	50	

\*<sup>(1)</sup> With terminals for connection\*<sup>(2)</sup> Mounting without connection terminals or terminals + phase barriers DT-90025

#### Normal service conditions:

Ambient air temperature (°C): -5°...+40°. Maximum altitude: 2.000 m. Maximum humidity: 90%. Pollution degree: 3 (standard for industrial applications). Rated frequency at AC utilization categories: 50/60 Hz.

Rated duties at utilization categories AC21A, AC22A and AC23A: Continuing (8 hours); uninterrupted.



# T

## Door mounting switch

### 1P up to 12P

Size 3

200|250|315



\* Under request also available  
in 400A, 500A, 630A, 800A,  
consult please



T

### Technical information



consult

consult

According to IEC 60947-3  
UL508 - CAN/CSA C22.2 N° 14

According to IEC 60947-3			T200	T250	T315	
Rated thermal current	I <sub>th</sub>	A	200	250	315	
Rated insulation voltage	U <sub>i</sub>	V	690	690	690	
Rated impulse withstand voltage	U <sub>imp</sub>	kV	8	8	8	
AC rated operational current	I <sub>e</sub>	U <sub>e</sub> 415V AC21A	A	200	250	315
		U <sub>e</sub> 415V AC22A	A	200	250	315
		U <sub>e</sub> 415V AC23A	A	200	200	200
Rated conditional short-circuit current		kA	15	15	15	
Rated maximum current	g <sub>L</sub> -g <sub>G</sub>	A	200	250	315	
Rated breaking capacity	400V; cos φ=0,45	A	1450	2000	2240	
Rated short-time withstand current (1 sec)		A	4400	4400	4400	
Mechanical durability (according to the standards, for other values please consult)			8000	8000	8000	
Rigid copper conductor		mm <sup>2</sup>	95	120	185	
Flexible copper conductor		mm <sup>2</sup>	95	120	185	
According to UL508 - CAN / CSA C22.2 N° 14			T200	T250	T315	
Rated thermal current	I <sub>th</sub>	A	200	200	200	
General use rating		V <sub>ac</sub>	600	600	600	
	3x240V	HP	60	60	60	
	3x480V	HP	75	75	75	
AC rated operational power	3x480V	HP	75	75	75	
	3x600V	HP	60	60	60	

#### Normal service conditions:

Ambient air temperature (°C): -5°...+40°. Maximum altitude: 2.000 m. Maximum humidity: 90%. Pollution degree: 3 (standard for industrial applications). Rated frequency at AC utilization categories: 50/60 Hz.

Rated duties at utilization categories AC21A, AC22A and AC23A: Continuing (8 hours); uninterrupted.

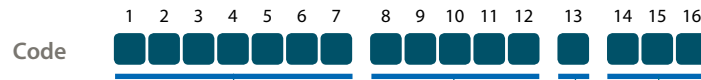

Series | Amp

T-00200
T-00250
T-00315

Diagram

Posit.	0	1	Chambers					
			1	2	3	4	5	6
1	X		00010					
2	X		00011					
3	X		00012					
4	X		00013					
5	X		01075					
6	X		01076					
7	X		01077					
8	X		01078					
9	X		01079					
10	X		01010					
11	X		01011					
12	X		01012					

Type

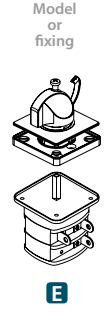

E

Plate and handle

	<b>1N1</b>	<b>1RD</b>	Arrow handle (from 1 to 4 poles)
	<b>AN1</b>	<b>ARD</b>	Simple handle (from 5 to 9 poles)
	<b>BN1</b>	<b>BRD</b>	Double handle (from 10 to 12 poles)
	<b>NN1</b>	<b>NRD</b>	Padlockable handle (from 1 to 9 poles)
	<b>ON1</b>	<b>ORD</b>	Padlockable handle (from 10 to 12 poles)

Dimensions (mm)

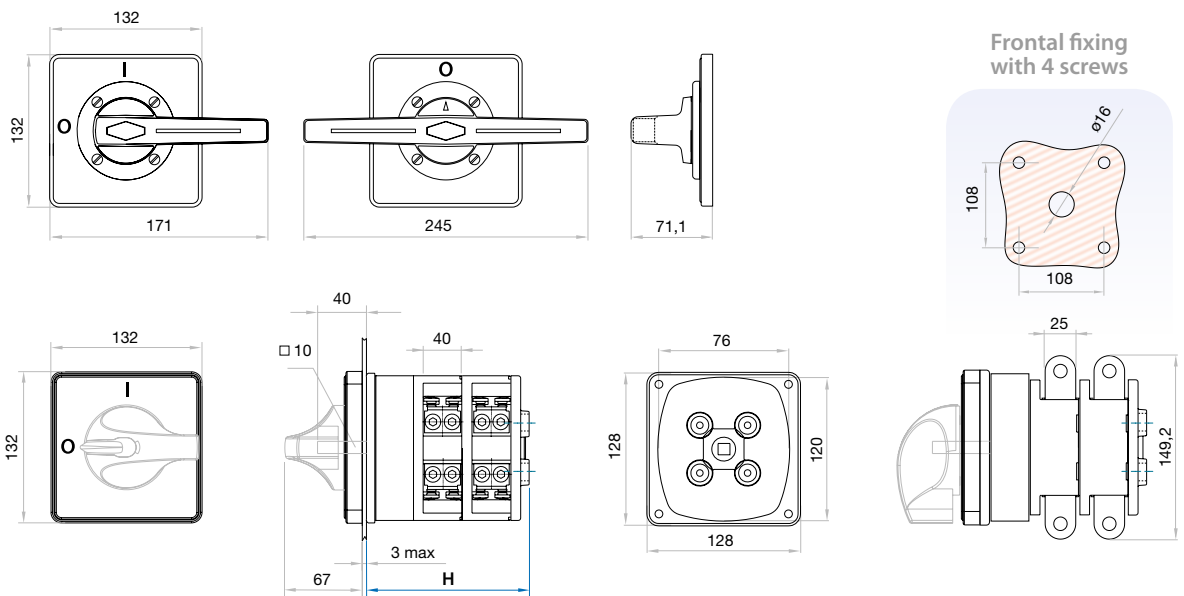

UL Terminal Lug

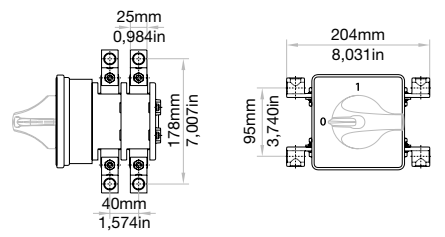

Terminal extensions according to UL

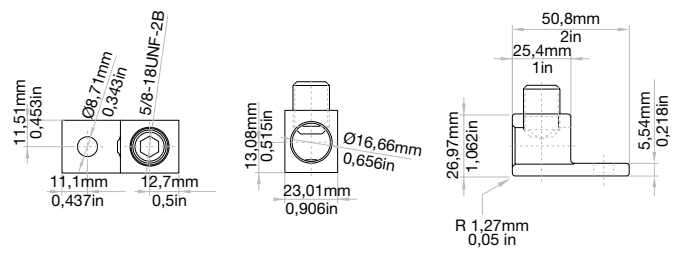

T series	Chambers	1	2	3	4	5	6
T200 T250 T315	H	95	135	175	215	255	295

Wire size	Wires per lug	Wire type	Kit reference
150 mm <sup>2</sup> / 300 kcmil	1	Cu/Al	DS-TL01 (2 pieces)

Note: The hardware needed to complete the wiring is supplied as standard.

# TP | T | TB | TF

## Door mounting changeover

### 1P up to 4P

Size 0

A 10|12|16|20|25|32



### Technical information



consult

consult

consult

consult

According to IEC 60947-3  
UL508 - CAN/CSA C22.2 N° 14

According to IEC 60947-3			TP10	T12	T20	TB20	TB25	TB32	TF12	TF16	TF25	
Rated thermal current	I <sub>th</sub>	A	12	16	25	20	25	32	20	25	32	
Rated insulation voltage	U <sub>i</sub>	V	500	500	500	500	500	500	690	690	690	
Rated impulse withstand voltage	U <sub>imp</sub>	kV	4	6	6	4	4	4	6	6	6	
AC rated operational current	I <sub>e</sub>	U <sub>e</sub> 415V AC13A	A	10	-	-	-	-	-	-	-	
		U <sub>e</sub> 415V AC21A	A	12	16	25	20	25	32	20	25	32
		U <sub>e</sub> 415V AC22A	A	12	16	25	20	25	32	20	25	32
		U <sub>e</sub> 415V AC23A	A	10	10	25	20	25	32	8	16	20
Rated conditional short-circuit current		kA	5	10	10	5	5	5	5	5	5	
Rated maximum current	g <sub>L</sub> -g <sub>G</sub>	A	16	25	25	35	35	35	20	25	32	
Rated breaking capacity	400V; cos φ=0,45	A	80	80	100	160	200	256	100	160	200	
Rated short-time withstand current (1 sec)		A	100	240	400	240	400	500	350	400	500	
Mechanical durability (according to the standards, for other values please consult)			1000	10000	10000	10000	10000	10000	10000	10000	10000	
Rigid copper conductor		mm <sup>2</sup>	2x4	2x4	2x4	1x10 2x6	1x10 2x6	1x10 2x6	1x10	1x10	1x10	
Flexible copper conductor		mm <sup>2</sup>	2x2,5	2x2,5	2x2,5	1x6 2x4	1x6 2x4	1x6 2x4	1x6	1x6	1x6	
According to UL508 - CAN / CSA C22.2 N° 14			T12	T20				TF12	TF16	TF25		
Rated thermal current	I <sub>th</sub>	A	-	12	20	-	-	-	16	20	25	
General use rating		Vac	-	300	300	-	-	-	600	600	600	
	3x240V	HP	-	2	5	-	-	-	2	5	7,5	
	3x480V	HP	-	-	-	-	-	-	5	10	12	
AC rated operational power	3x600V	HP	-	-	-	-	-	-	5	10	15	

#### Normal service conditions:

Ambient air temperature (°C): -5°...+40°. Maximum altitude: 2.000 m. Maximum humidity: 90%. Pollution degree: 3 (standard for industrial applications). Rated frequency at AC utilization categories: 50/60 Hz.

Rated duties at utilization categories AC21A, AC22A and AC23A: Continuing (8 hours); uninterrupted.

Code 1 2 3 4 5 6 7 8 9 10 11 12 13 14 15 16

Series | Amp

- TP-0010
- T-00012
- T-00020
- TB-0020
- TB-0025
- TB-0032
- TF-0012
- TF-0016
- TF-0025

Diagram

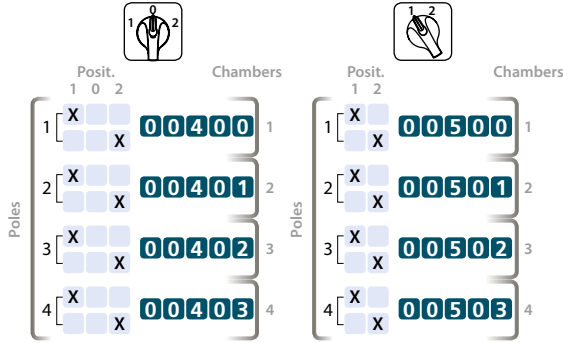

Type

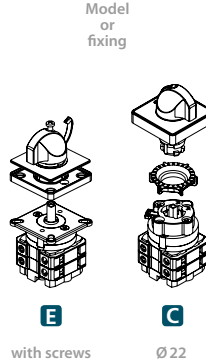
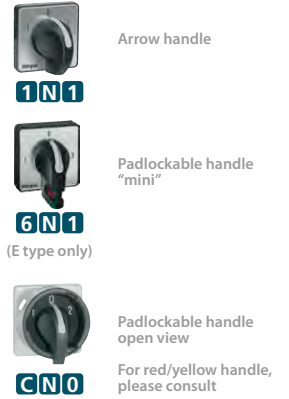

Plate and handle



Dimensions (mm)

**E**

Frontal fixing  
with 2 screws

TB      T- TF

Frontal fixing  
with 4 screws

T- TB- TF- TP

**C**

Frontal fixing  
Ø22

T- TB- TF

TP series	Chambers	1	2	3	4
<b>H1</b>		26,8	36,3	45,8	55,3

T series	Chambers	1	2	3	4
<b>L1</b>		34,5	46	57,5	69
<b>H2</b>		37,5	49	60,5	72

TB series	Chambers	1	2	3	4
<b>H3</b>		31,5	41,5	51,5	61,5

TF series	Chambers	1	2	3	4
<b>L2</b>		45	55	65	75
<b>H4</b>		48	58	68	78

# T

## Door mounting changeover

### 1P up to 4P

Size 1

A 16|25|32|40



T

### Technical information



consult

consult

consult

consult

According to IEC 60947-3  
UL508 - CAN/CSA C22.2 N° 14

According to IEC 60947-3			T16	T25	T32	T40	
Rated thermal current	I <sub>th</sub>	A	25	32	40	50	
Rated insulation voltage	U <sub>i</sub>	V	690	690	690	690	
Rated impulse withstand voltage	U <sub>imp</sub>	kV	6	6	8	8	
AC rated operational current	I <sub>e</sub>	U <sub>e</sub> 415V AC21A	A	25	32	40	50
		U <sub>e</sub> 415V AC22A	A	25	32	40	50
		U <sub>e</sub> 415V AC23A	A	16	20	25	32
Rated conditional short-circuit current		kA	10	10	10	10	
Rated maximum current	gL-gG	A	32	32	50	50	
Rated breaking capacity	400V; cos φ=0,45	A	160	200	256	320	
Rated short-time withstand current (1 sec)		A	500	650	800	800	
Mechanical durability (according to the standards, for other values please consult)			10000	10000	10000	10000	
Rigid copper conductor		mm <sup>2</sup>	2x6	2x6	2x10	2x10	
Flexible copper conductor		mm <sup>2</sup>	2x4	2x4	2x6	2x6	
According to UL508 - CAN / CSA C22.2 N° 14			T16	T25	T32	T40	
Rated thermal current	I <sub>th</sub>	A	16	25	32	40	
General use rating		Vac	600	600	600	600	
	3x240V	HP	5	7,5	10	15	
	3x480V	HP	10	15	20	25	
AC rated operational power	3x600V	HP	10	15	20	25	

#### Normal service conditions:

Ambient air temperature (°C): -5°...+40°. Maximum altitude: 2.000 m. Maximum humidity: 90%. Pollution degree: 3 (standard for industrial applications). Rated frequency at AC utilization categories: 50/60 Hz.

Rated duties at utilization categories AC21A, AC22A and AC23A: Continuing (8 hours); uninterrupted.

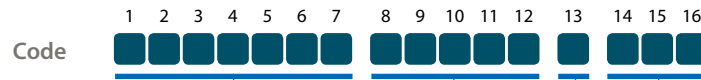

- Series | Amp
- T-00016
  - T-00025
  - T-00032
  - T-00040

Diagram

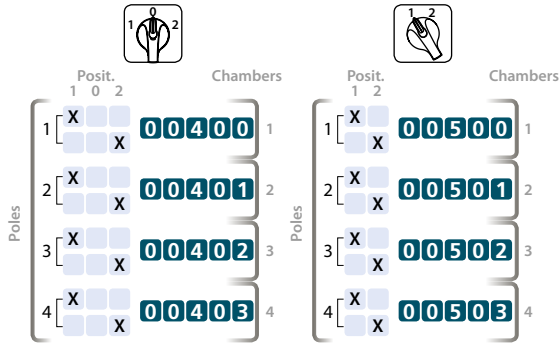

Type

Plate and handle

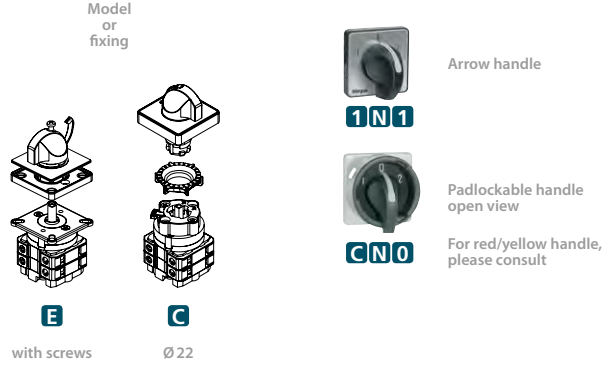

Dimensions (mm)

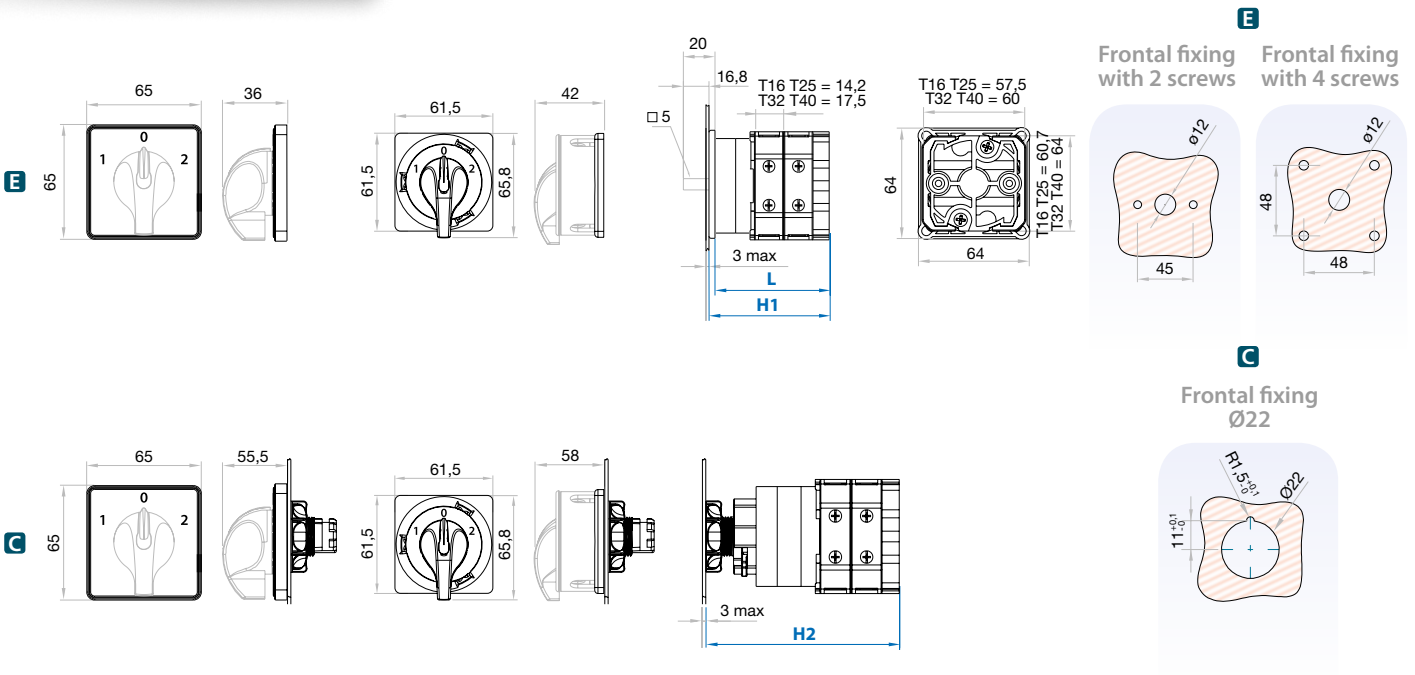

T series	Chambers	1	2	3	4
T16 T25	L	46,4	60,6	74,8	89
	H1	49,6	63,8	78	92,2
	H2	75,5	89,5	103,7	117,9
T32 T40	L	49,8	67,3	84,8	102,3
	H1	53	70,5	88	105,5
	H2	78,8	96,3	113,8	131,3

>> For more information of this series; accessories see pages 24-31 | diagrams see pages 32-43

# T

## Door mounting changeover

### 1P up to 4P

Size 2

A 50|63|80|100|125|175



\* Except T175



T

### Technical information



consult

consult

consult

According to IEC 60947-3  
UL508 - CAN/CSA C22.2 N° 14

According to IEC 60947-3			T50	T63	T80	T100	T125	T175	
Rated thermal current	I <sub>th</sub>	A	63	80	80	125	125	200	
Rated insulation voltage	U <sub>i</sub>	V	690	690	690	690	690	1000	
Rated impulse withstand voltage	U <sub>imp</sub>	kV	8	8	8	8	8	8	
AC rated operational current	I <sub>e</sub>	U <sub>e</sub> 415V AC21A	A	63	80	80	125	125	200
		U <sub>e</sub> 415V AC22A	A	63	80	80	115	115	200
		U <sub>e</sub> 415V AC23A	A	63	63	63	100	100	200
Rated conditional short-circuit current		kA	15	15	15	15	15	15 <sup>(2)</sup>	
Rated maximum current	gL-gG	A	80	80	80	125	125	160	
Rated breaking capacity	400V; cos φ=0,45	A	504	504	504	640	640	1600	
Rated short-time withstand current (1 sec)		A	1600	1600	1600	2500	2500	3500	
Mechanical durability (according to the standards, for other values please consult)			10000	10000	10000	8000	8000	8000	
Rigid copper conductor		mm <sup>2</sup>	16/25 <sup>(1)</sup>	16/25 <sup>(1)</sup>	16/25 <sup>(1)</sup>	35/50 <sup>(1)</sup>	35/50 <sup>(1)</sup>	95	
Flexible copper conductor		mm <sup>2</sup>	10/16 <sup>(1)</sup>	10/16 <sup>(1)</sup>	10/16 <sup>(1)</sup>	16/35 <sup>(1)</sup>	16/35 <sup>(1)</sup>	95	
According to UL508 - CAN / CSA C22.2 N° 14			T50	T63	T80	T100	T125	T175	
Rated thermal current	I <sub>th</sub>	A	63	63	63	100	100	200	
General use rating		Vac	600	600	600	600	600	600	
	3x240V	HP	20	20	20	30	30	25	
	3x480V	HP	40	40	40	50	50	60	
AC rated operational power	3x600V	HP	40	40	40	50	50	50	

\*<sup>(1)</sup> With terminals for connection\*<sup>(2)</sup> Mounting without connection terminals or terminals + phase barriers DT-90025

#### Normal service conditions:

Ambient air temperature (°C): -5...+40°. Maximum altitude: 2.000 m. Maximum humidity: 90%. Pollution degree: 3 (standard for industrial applications). Rated frequency at AC utilization categories: 50/60 Hz.

Rated duties at utilization categories AC21A, AC22A and AC23A: Continuing (8 hours); uninterrupted.

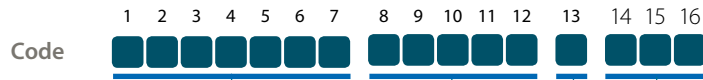

Series | Amp

- T-00050
- T-00063
- T-00080
- T-00100
- T-00125
- T-00175

Diagram

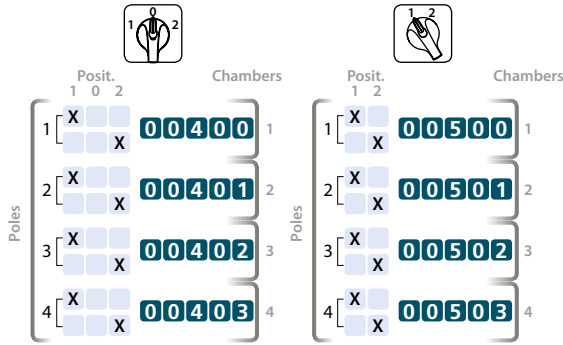

Type

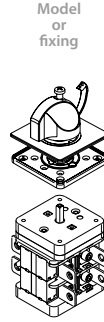

Plate and handle



Arrow handle



Padlockable handle open view



For red/yellow handle, please consult

Dimensions (mm)

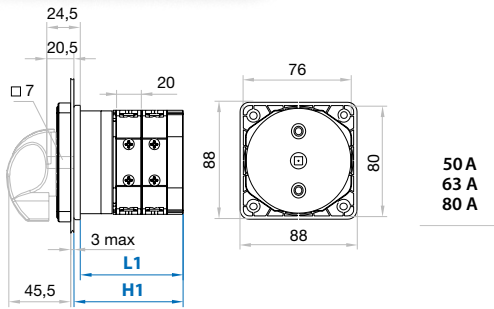

Frontal fixing with 2 screws

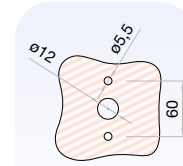

Frontal fixing with 4 screws

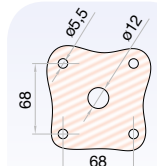

T series	Chambers	1	2	3	4
T50 T63 T80	L1	58,5	78,5	98,5	118,5
	H1	62,5	82,5	102,5	122,5

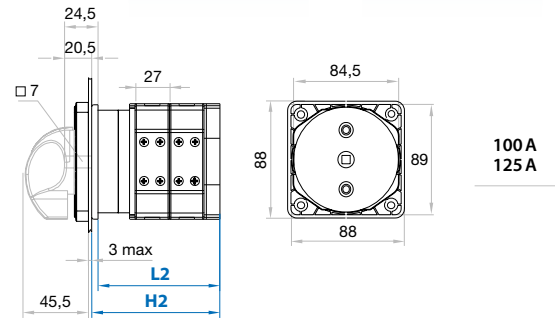
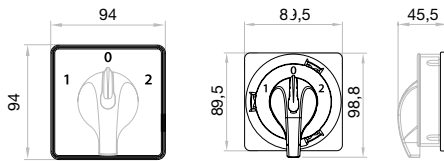

UL Terminal Lug

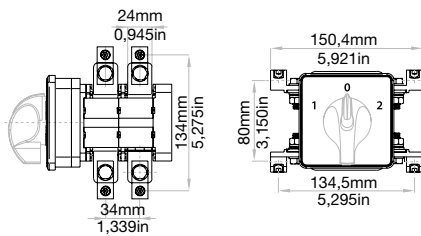

T series	Chambers	1	2	3	4
T100 T125	L2	67	94	121	148
	H2	71	98	125	152

Terminal extensions according to UL.

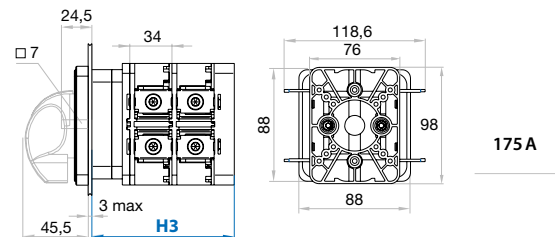
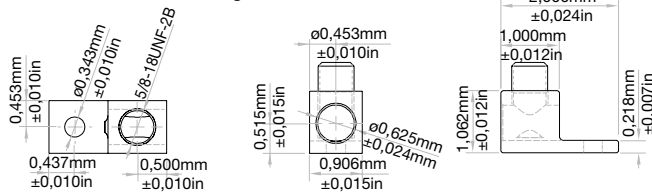

T series	Chambers	1	2	3	4
T175	H3	80,8	114,8	148,8	182,8

Wire size	Wires per lug	Wire type	Kit reference
120 mm <sup>2</sup> / 250 kcmil	1	Cu	DS-TLU21 (2 pieces)

Note: The hardware needed to complete the wiring is supplied as standard.

» For more information of these series; accessories see pages 24-31 | diagrams see pages 32-43

# T

## Door mounting changeover

### 1P up to 4P

Size 3

A\* 200|250|315



\* Under request also available  
in 400A, 500A, 630A, 800A,  
consult please



T

### Technical information



consult

consult

According to IEC 60947-3  
UL508 - CAN/CSA C22.2 N° 14

According to IEC 60947-3			T200	T250	T315	
Rated thermal current	I <sub>th</sub>	A	200	250	315	
Rated insulation voltage	U <sub>i</sub>	V	690	690	690	
Rated impulse withstand voltage	U <sub>imp</sub>	kV	8	8	8	
AC rated operational current	I <sub>e</sub>	U <sub>e</sub> 415V AC21A	A	200	250	315
		U <sub>e</sub> 415V AC22A	A	200	250	315
		U <sub>e</sub> 415V AC23A	A	200	200	200
Rated conditional short-circuit current		kA	15	15	15	
Rated maximum current	g <sub>L</sub> -g <sub>G</sub>	A	200	250	315	
Rated breaking capacity	400V; cos φ=0,45	A	1450	2000	2240	
Rated short-time withstand current (1 sec)		A	4400	4400	4400	
Mechanical durability (according to the standards, for other values please consult)			8000	8000	8000	
Rigid copper conductor		mm <sup>2</sup>	95	120	185	
Flexible copper conductor		mm <sup>2</sup>	95	120	185	
According to UL508 - CAN / CSA C22.2 N° 14			T200	T250	T315	
Rated thermal current	I <sub>th</sub>	A	200	200	200	
General use rating		Vac	600	600	600	
	3x240V	HP	60	60	60	
	3x480V	HP	75	75	75	
AC rated operational power	3x480V	HP	75	75	75	
	3x600V	HP	60	60	60	

#### Normal service conditions:

Ambient air temperature (°C): -5°...+40°. Maximum altitude: 2.000 m. Maximum humidity: 90%. Pollution degree: 3 (standard for industrial applications). Rated frequency at AC utilization categories: 50/60 Hz.

Rated duties at utilization categories AC21A, AC22A and AC23A: Continuing (8 hours); uninterrupted.

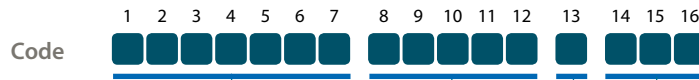

Series | Amp

T-00200  
T-00250  
T-00315

Diagram

Type

Plate and handle

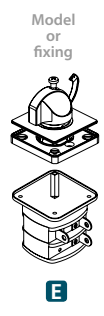
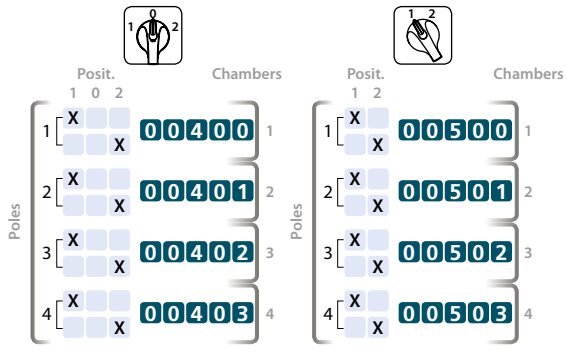

Dimensions (mm)

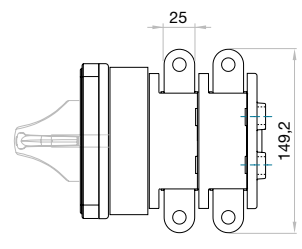
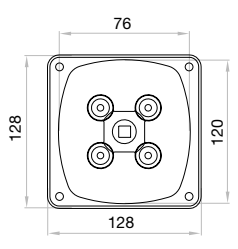
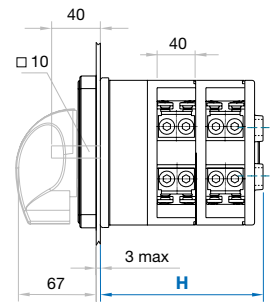
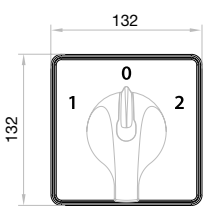
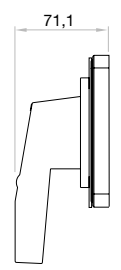
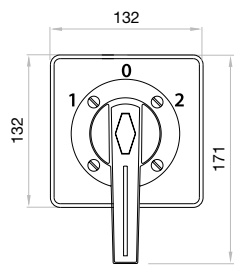

Frontal fixing with 4 screws

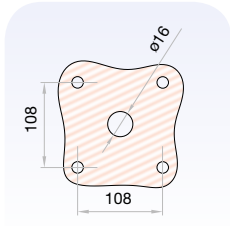

UL Terminal Lug

Terminal extensions according to UL

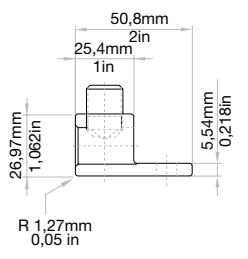
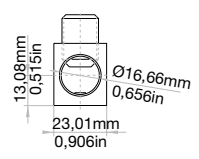
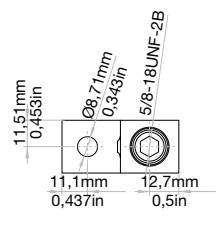
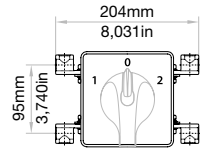
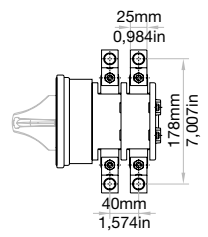

T series	Chambers	1□	2□	3□	4□
T200 T250 T315	H	95	135	175	215

Wire size	Wires per lug	Wire type	Kit reference
150 mm <sup>2</sup> / 300 kcmil	1	Cu/Al	DS-TL01 (2 piezas)

>> For more information of this serie; accessories see pages 24-31 | diagrams see pages 32-43

14 15 16  
D100 4



Light with white neon lamp  
**D100**

14 15 16  
D101 5



Light with white neon lamp  
and inscription plate  
**D101**

**D101** Inscription plate included with text as requested.

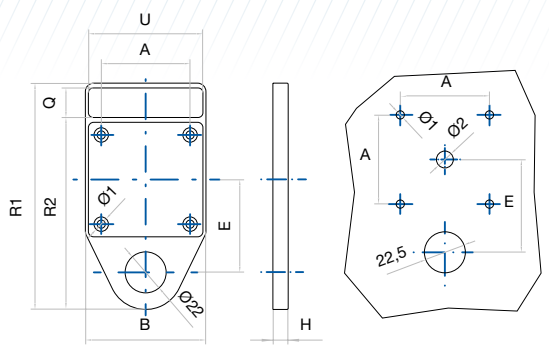

Supply	Size	For series	Code D100	Code D101
Spare or incorporated in the cam switch	0-1	T12-T20-TB20-TB25-TB32 TF12-TF16-TF25 T16-T25-T32-T40	DT-10011	DT-10111
	2	T50-T63-T100-T175	DT-10021	DT-10121
	3	T200	DT-10031	DT-10131

Series	B	R1	R2	H	E	U	Q	A	Ø1	Ø2
T12 T20 T16 T25 T32 T40 TB20 TB32 TF12 TF25	65	123	102	6,5	50	61	16	48	4,5	9
T50 T63 T100 T175	94	160	137	7,5	70	90	19	68	5,5	12
T200 T800	132	198	173	10	85	126	21	108	6,5	16

13 14 15 16  
D201 E

13 14 15 16  
D200 D



Tandem drive operation\*  
**D200** with two columns  
**D201** with three columns

13 14 15 16  
D301 G

13 14 15 16  
D300 F



Blocking operation\*  
**D300** with two columns  
**D301** with three columns

**D200-201** Operation with one handle only and up to 48 contacts in two columns, or 72 contacts in three columns according to the electrical diagram.

**D300-301** For switching up to 29 positions with two handles and two columns, or 36 positions with three handles and three columns according to the electrical diagram.

Supply	Size	For series
Only incorporated in the cam switch	0-1	T12-T20-TF12-TF16-TF25 T16-T25-T32-T40
	2	T50-T63-T100
	3	T175- T200

\*T Series (without IP20 protections).

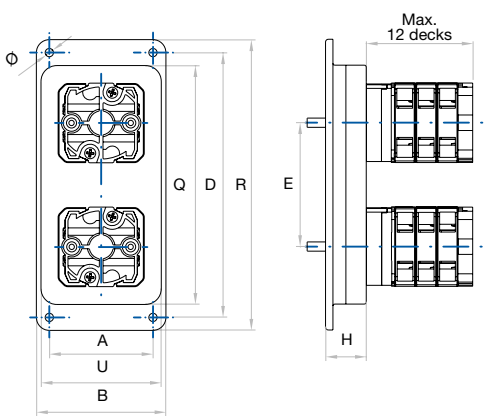

Series												
	Tandem	Blocking	A	B	D	R	U	Q	E	Tandem H	Blocking Ø	
T12 T20 T16 T25 T32 T40 TF12 TF16 TF25	D200	D300			143	157		128	67	22	22	4,5
	D201	D301	56	70	210	224	64	195				
T50 T63 T100	D200	D300			210	230		191	97	15	21	
	D201	D301	90	110	306	326	95	288				6,5
T175 T200	D200	D300			290	310		270	139	19	25	
	D201	D301	152	173	426	447	132	407				



TITBITF series

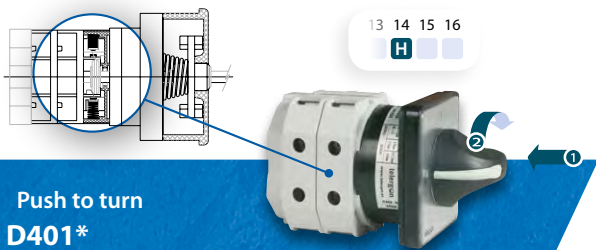

Push to turn  
**D401\***

Before operating the handle must be pressed to unlock, simultaneously an auxiliary contact is open or closed (e.g. for switching without load).

Supply	Size	For series
Only incorporated in the cam switch	0	T12-T20-TB20-TB25-TB32
	1	T16-T25-T32-T40

\* for arrow handle with indicator, other combinations with special scheme

One way rotation  
**D405**



This device allows to rotate the handle just in one way.

Supply	Size	For series
Only incorporated in the cam switch	0-1	T12-T20-TB20-TB25-TB32
		TF12-TF16-TF25
		T16-T25-T32-T40

Dual voltage locking device  
**D420**



The screw position, at left or at right, prevents the rotation of the handle.  
This device always includes a mounting plate size 1.

Supply	Size	For series
Only incorporated in the cam switch	0-1	T12-T20-TB20-TB25-TB32
		TF12-TF16-TF25
		T16-T25-T32-T40

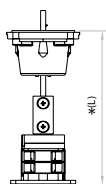

Shaft extension

To extend the shaft length to the depth required.  
To be complemented with the corresponding D501 device.

Supply	Size	Length (mm)	For series	Code
Spare or incorporated in the cam switch	0-1	200	T12-T20-TB20-TB25-TB32	DT-EPR11
		500	TF12-TF16-TF25 T16-T25-T32-T40	DT-EPR12
	2	200	T50-T63	DT-EPR21
		500	T100-T175	DT-EPR22
Only incorporated in the cam switch	3	upon request	T200	-

\*<sup>(L)</sup> Specify total length when ordering

Clutch device with door interlock  
**D501**



With door interlock in ON position (switch 0-1 to 90°) or according to the electrical diagram.

- 1 Size 0 with padlockable handle included.
- 2 Size 0 - 1 - 2 - 3.

Supply	Size	For series	Code	
1	D501 + 704 90°	0	DT-75401N07	
			DT-75401R01	
			12 13 14 15 16 F 6 N 1	
2	90°	0	DT-50102	
			1	DT-50101
			2	DT-50121
		3	DT-50131	
		60°	0-1	DT-50104
				2
	3			DT-50134
	45°	0-1	DT-50103	
			2	DT-50123
			3	DT-50133
	Incorporated in the cam switch			12 13 14 15 16 F

series  
**T|TB|TF**

12 13 14 15 16  
**B**



**Coaxial coupling  
D600**

Simultaneous operation of two or more cam switches of different size (T series) coupled together with only one handle.

12 13 14 15 16  
**D701 Keya Z 4 1 B**



**Key handle device  
D701**

**D701** Supplied as standard with  $\varnothing 22\text{mm}$  fixing;  $\varnothing 30\text{ mm}$  also available under request.

The key can be locked and removed on request at  $60^\circ$ ,  $90^\circ$  or  $180^\circ$ .

Assembly limitation:  
4 contacts actuating simultaneously.

**D711** Supplied as standard with screw mounting and different types of keys that can be locked and removed at  $90^\circ$ .

Assembly limitation:  
4 contacts actuating simultaneously.

13 14 15 16  
**D711 Keya M 1 1**



**Key handle device  
D711**

Supply	Size	For series
Only incorporated in the cam switch	0-1	T12-T20-TB20-TB25-TB32 TF12-TF16-TF25 T16-T25-T32-T40

**D701**

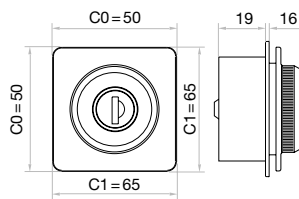

**D711**

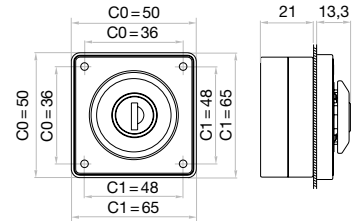

14 15 16  
**D702 6**



**Key lock device  
D702**

**D702** The key lock device allows the adaptation of 1 or 2 auxiliary contacts (1NO + 1NC) operated by turning the key (like signalling or control contacts).

**D703** Inscription plate included with text as requested.

14 15 16  
**D703 7**



**Key lock device  
with inscription plate  
D703**

Supply	Size	For series
Only incorporated in the cam switch	0-1	T12-T20-TB20-TB25-TB32 TF12-TF16-TF25 T16-T25-T32-T40
	2	T50-T63 T100-T175
	3	T200

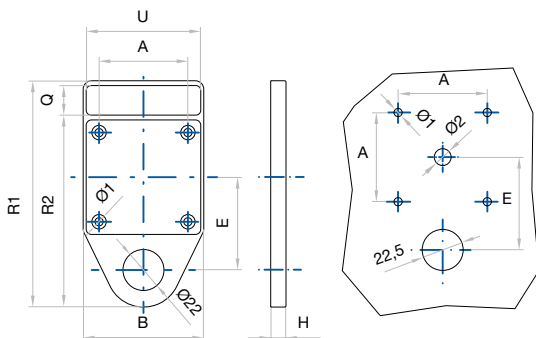

**\* Auxiliary contacts 1NO + 1NC**



Series	B	R1	R2	H	E	U	Q	A	$\varnothing 1$	$\varnothing 2$
T12 T20 T16 T25 T32 T40 TB20 TB32 TF12 TF25	65	123	102	6,5	50	61	16	48	4,5	9
T50 T63 T100 T175	94	160	137	7,5	70	90	19	68	5,5	12
T200 T800	132	198	173	10	85	126	21	108	6,5	16

Padlockable handle  
D704

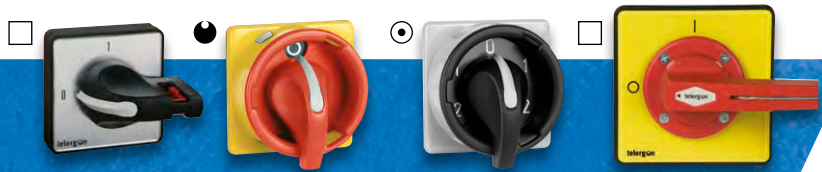

- > Allows the blockade of the handle in OFF position using padlock.
- > Available in red colour on yellow background <sup>15</sup>R or black colour on grey background <sup>15</sup>N
- > According to the machinery directive and the european standards, red & yellow handles <sup>15</sup>R are intended to be used only in ON - OFF safety switches.
- > For switches O-I specify version <sup>15</sup>R or <sup>15</sup>N, for the rest will be supplied <sup>15</sup>N version (padlocks not included).

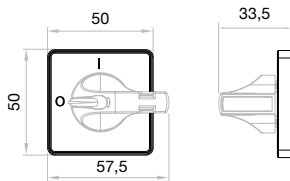

Size 0

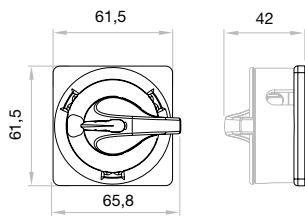

Size 0-1

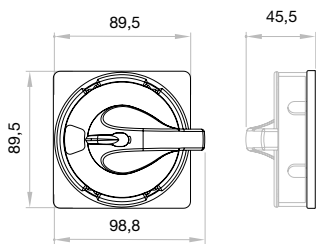

Size 2

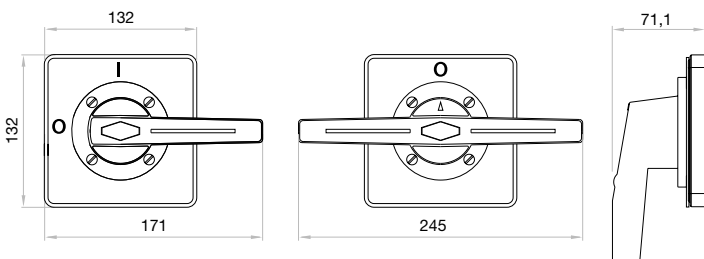

Size 3

	Supply	Size	For series	Code
□ Square plate	Spare	0	T12-T20 TB20-TB25-TB32 TF12-TF16-TF25 TP10	● DT-70401N07
	Incorporated in the cam switch			● DT-70401R01*
● Closed view	Spare	0 - 1	T12-T20 TB20-TB25-TB32 TF12-TF16-TF25 T16-T25-T32-T40	● DT-7041CN02
	Incorporated in the cam switch			● DT-7041CR02
○ Open view	Spare	2	T50-T63 T100-T175	● DT-7041AN02
	Incorporated in the cam switch			● DT-7041AR02
● Closed view	Spare	3	T200	● DT-7042CN02
	Incorporated in the cam switch			● DT-7042CR02
○ Open view	Spare	3	T200	● DT-7042AN02
	Incorporated in the cam switch			● DT-7042AR02
□ Square plate (single handle)	Spare	3	T200	● DT-70431
	Incorporated in the cam switch			● DT-70433*
□ Square plate (double handle)	Spare	3	T200	● DT-70432
	Incorporated in the cam switch			● DT-70434*

\* Yellow plate with 0 - 1 positions included

**Padlockable handle with inscription plate  
D705**



- > Handle can be blocked in OFF position using padlocks.
- > Available in red colour on yellow background <sup>15</sup>R or black colour on grey background <sup>15</sup>N
- > Inscription plate included with text as requested.
- > According to the machinery directive and the european standards, red & yellow handles <sup>15</sup>R are intended to be used only in ON - OFF safety switches.
- > For switches O-I specify version <sup>15</sup>R or <sup>15</sup>N, for the rest will be supplied <sup>15</sup>N version (padlocks not included).

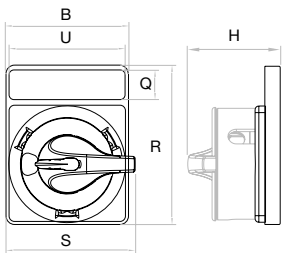

Size	B	H	Q	R	S	U
0-1	65	48,5	16	85	65,8	61
2	94	53,5	19	117	98,8	90
3	132	71,5	21	157	171 245	126

	Supply	Size	For series	Code
● Closed view	Only incorporated in the cam switch	0-1	T12-T20 TB20-TB25-TB32 TF12-TF16-TF25 T16-T25 T32-T40	● 13 14 15 16 <b>7 N 2</b>
				● 13 14 15 16 <b>7 R 2</b>
⊙ Open view	Only incorporated in the cam switch			● 13 14 15 16 <b>C N 2</b>
				● 13 14 15 16 <b>C R 2</b>
● Closed view	Only incorporated in the cam switch	2	T50-T63 T100-T175	● 13 14 15 16 <b>7 N 2</b>
				● 13 14 15 16 <b>7 R 2</b>
⊙ Open view	Only incorporated in the cam switch			● 13 14 15 16 <b>C N 2</b>
				● 13 14 15 16 <b>C R 2</b>
□ Square plate (single handle)	Only incorporated in the cam switch	3	T200	● 13 14 15 16 <b>N N 2</b>
				● 13 14 15 16 <b>N R 2</b>
□ Square plate (double handle)	Only incorporated in the cam switch			● 13 14 15 16 <b>O N 2</b>
				● 13 14 15 16 <b>O R 2</b>



**Push button blocking system  
D708**



**Push button blocking system with inscription plate  
D709**

**D708** Available in two versions (specify when ordering):

- 1) The handle is blocked in all positions.
- 2) The handle is blocked only in OFF position.

The switch in version 2 can be used for emergency operation since the handle is not blocked in ON position. Both versions admit the adaptation of 1 and 2 changeover auxiliary contacts (1NO+1NC), which are activated when the button is pressed and it can be used as signalling and combined operation with contactors.

**D709** Inscription plate included with text as requested.

Supply	Size	For series
Only incorporated in the cam switch	0-1	T12-T20-TB20-TB25 TB32-TF12-TF16-TF25 T16-T25-T32-T40
	2	T50-T63-T100-T175
	3	T200

\* Auxiliary contacts 1NO + 1NC 2NO + 2NC

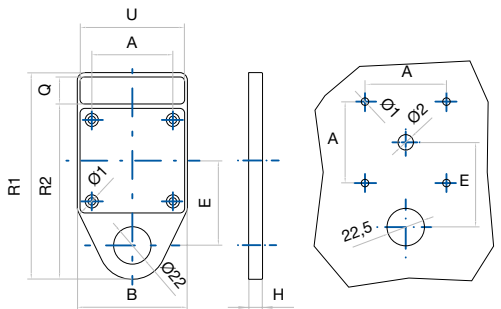

Series	B	R1	R2	H	E	U	Q	A	Ø1	Ø2
T12 T20 T16 T25 T32 T40 TB20 TB32 TF12 TF25	65	123	102	6,5	50	61	16	48	4,5	9
T50 T63 T100 T175	94	160	137	7,5	70	90	19	68	5,5	12
T200 T800	132	198	173	10	85	126	21	108	6,5	16

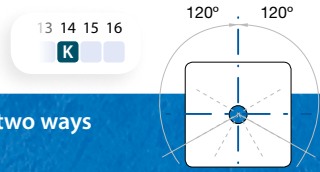

**Return from one or two ways up to 120°**  
**D802**

Supply	Size	For series
Only incorporated in the cam switch	0-1	T12-T20-TB20-TB25-TB32 TF12-TF16-TF25 T16-T25-T32-T40



**Terminal shrouds**  
**D900**

Sizes 0-1 and 2 are supplied as standard with removable protected terminals (IP20).

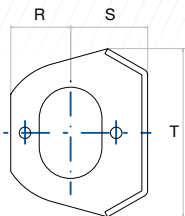

Series	R	S	S
T12 T20	21	27	59
T16 T25 T32 T40	28	34	72
T50 T63 T100	15	52	104
T200	40	155	130

Supply	Size	For series	Code
	0	T12-T20	DT-90002
	1	T16-T25-T32-T40	DT-90012
	2	T50-T63	DT-90022
Spare	2	T100	DT-90024
		T200	DT-90031
	3*	T400	DT-90032

\* Max. 2 chambers

**T175 terminal shrouds and phase barriers**  
**D900**

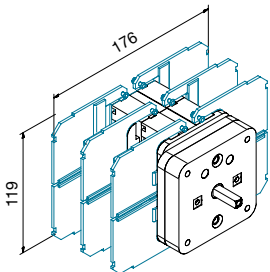

**Phase barriers - Vertical**  
Code DT-90025 (4 units)

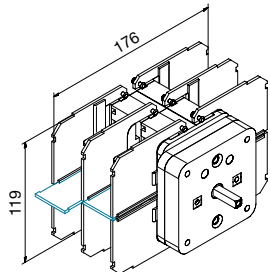

**Phase barriers - Horizontal**  
Code DT-90026 (2 units)

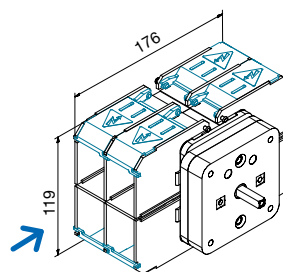

**Terminal shrouds (L)**  
Code DT-90027 (4 units)

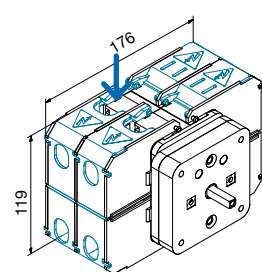

**Terminal shrouds (S)**  
Code DT-90028 (4 units)



**DIN rail mounting device**  
**D904**

**Front plates for distribution boards**  
**D905**



**D904** Included as standard in D-F-G fixing types for TB-TF and T175 series.  
**D905** DIN rail mounting with frontal plate and handle for distribution boards.

	Supply	Size	For series	Code
D904	Spare or incorporated in the cam switch	0-1	T12-T20-T16 T25-T32-T40	DT-90401
		2	T50-T63-T100-T175	DT-90421
D905	Only incorporated in the cam switch	0	T12-T20 TF12-TF16-TF25	12 13 14 15 16 H 8 N O

Handles (plastic)

13 14 15 16  
1 N



13 14 15 16  
1 R



13 14 15 16  
2 N



13 14 15 16  
2 R



13 14 15 16  
B N



13 14 15 16  
B R



- > <sup>14</sup> 1 Arrow handle with indicator.
- > <sup>14</sup> 2 Ball lever handle for size 1 and 3.
- > <sup>14</sup> B Double handle for cam switches size 3.

	Supply	Size	Code		
Arrow handle with indicator	Spare or incorporated in the cam switch	0	● 40110030 ● 40110031		
		1	● 40111034 ● 40111035		
		2	● 40112028 ● 40112029		
		3	● 40113023 ● 40113024		
		Ball lever	Spare or incorporated in the cam switch	1	● 40111002 ● 40111003
				3	● 40113002 ● 40113001
3	● 40113008 ● 40113007				

Arrow handle with indicator (sizes 0 - 1 - 2 - 3)

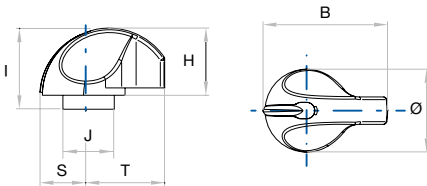

Size	B	H	I	J	S	T	Ø
0	39,3	26,8	30,5	14,5	13,5	24	27
1	50	28	33	14,5	18	32	36
2	66,5	36,5	-	-	22,5	44	45
3	100	54	-	-	38	62	76

Ball lever (sizes 1 - 3)

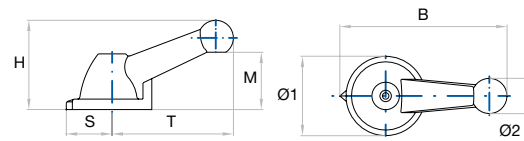

Size	B	H	S	T	M	Ø1	Ø2
1	89	48	24	65	32,5	37	18
3	151,5	81	41,5	110	52	72	32

Double handle (size 3)

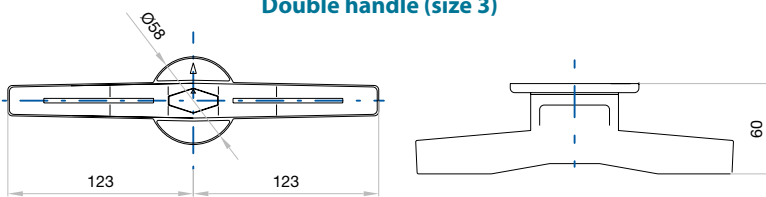

Handles (metal & plastic)

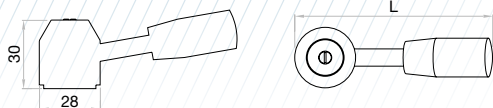

	Supply	Size	Code
Metal lever & plastic	Spare or incorporated in the cam switch	L=90mm	9-KN100146
		L=108mm	9-KN100145



13 14 15 16



Neutral name plates and neutral inscription plates

- > Plastic indicating plate on square base with black engraving
- > Also in yellow colour available (emergency handle).
- > Different engravings are available under request.
- > PPA model with inscription plate.

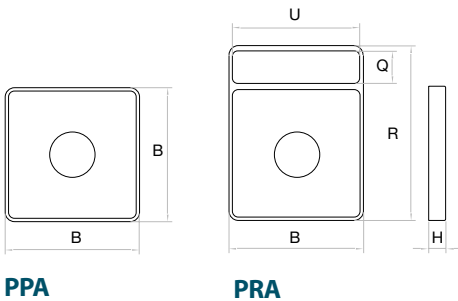

Size	B	R	H	U	Q
0	50	65	6,5	47	11
1	65	85	6,5	61	16
2	94	117	7	90	19
3	132	157	10	126	21

	Supply	Size	Code		
PPA (neutral plate)					
	Spare or incorporated in the cam switch	0	40140045	40140061	40110028
		1	40141039	40141053	40111032
		2	40142020	40142028	40142025
		3	40143020	40143028	40143084
		Size	Code		
PRA (neutral plate)					
	Spare or incorporated in the cam switch	0	40140203		40110029
		1	40141188		40111033
		2	40142095		40112026
		3	40143088		40143086

Terminal extensions CP

Supply	Size	For series
Only incorporated in the cam switch	0	T12-T20
	1	T16-T25-T32-T40
	2	T50-T63-T100

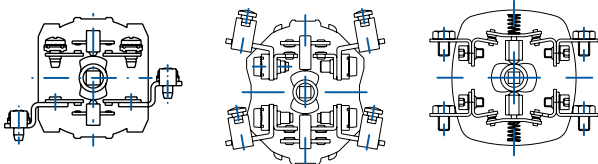

T12-T16-T20-T25    T32-T40-T63-T100    T200 standard connection as per drawing

Fast-on terminals 6,25 x 0,8



Supply	Size	For series
Only incorporated in the cam switch	0-1	T12-T20 T16-T25-T32-T40

# TP | T | TB | TF Standard diagrams

For many switching operations that can be resolved using cam switches, we have a number of standard schemes applicable to the most common applications in electrical installations, equipment, machinery, etc. If you do not find what you are looking for in this selection, or have a special switching requirement, you can use the blank diagrams form on the next page and send it to our sales department. The descriptive logic representing and interpreting the circuits are explained below.

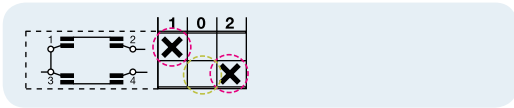

**X** It represents "closed contact".

**□** It represents "opened contact".

The contact 1/2 is closed in position 1 and opened in positions 0 & 2.

The contact 3/4 is closed in position 2 and opened in positions 0 & 1.

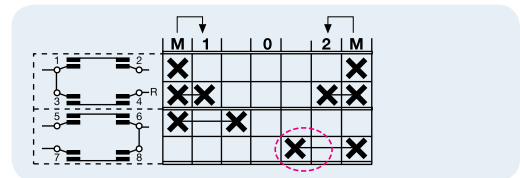

**X-X** They represent "late break contact" or "early-make contact" in relation to others.

The contacts 5/6 & 7/8 close before the contacts 3/4 & 1/2 and they will also open after these contacts.

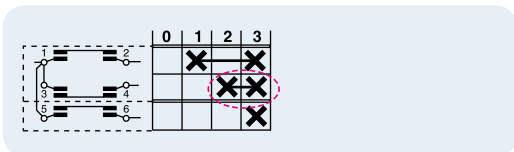

**X-X** It represents closed contact "without interruption".

The contact 1/2 closes in position 1, and remains closed in position 2 & 3.

The contact 3/4 closes in position 2 and remains closed in position 3.

When passing from one position to another there is no contact interruption in any cases.

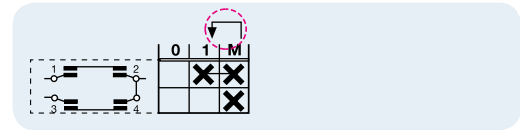

**↩** It represent "spring return" to previous position.

The M position is not fixed and it will return to position 1 when the handle is released.

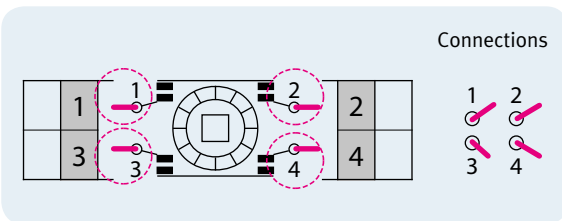

Connection point.

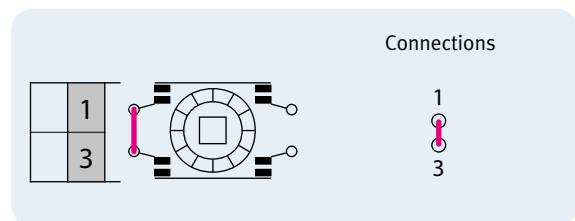

Vertical bridging link.

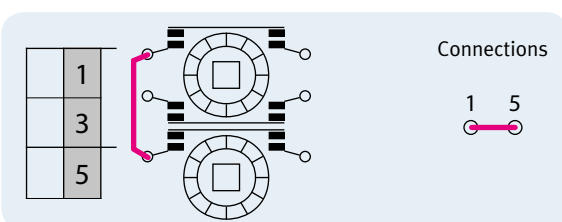

Horizontal bridging link.



On-Off switches

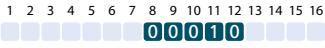
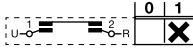
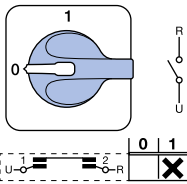

**010**  
1 pole  
1 chamber  
**010/5** 5 poles  
**010/6** 6 poles  
**010/7** 7 poles  
**010/8** 8 poles  
**010/9** 9 poles

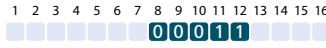
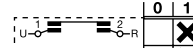
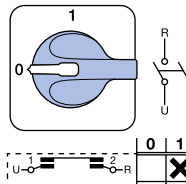

**011**  
2 poles  
1 chamber  
**010/10** 10 poles  
**010/11** 11 poles  
**010/12** 12 poles  
**010/13** 13 poles  
**010/14** 14 poles

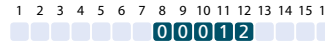
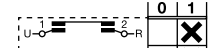
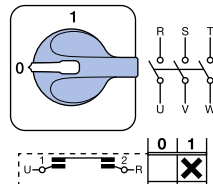

**012**  
3 poles  
2 chambers  
**010/15** 15 poles  
**010/16** 16 poles  
**010/17** 17 poles  
**010/18** 18 poles  
**010/19** 19 poles

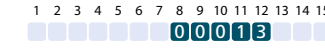
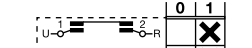
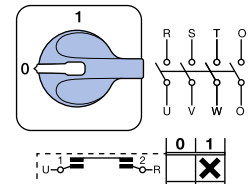

**013**  
4 poles  
2 chambers  
**010/20** 20 poles  
**010/21** 21 poles  
**010/22** 22 poles  
**010/23** 23 poles  
**010/24** 24 poles

To view these wiring diagrams please visit our download area on [www.telergon.com](http://www.telergon.com)

On-Off switches with contacts leading when making

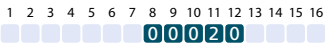
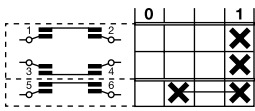
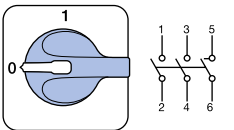

**020**  
3 poles 1 preclosed pole  
2 chambers

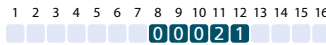
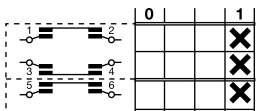
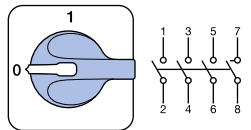

**021**  
4 poles 1 preclosed pole  
2 chambers

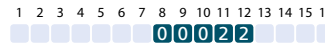
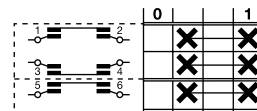
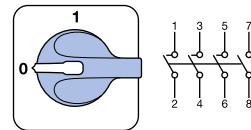

**022**  
4 poles 3 preclosed poles  
2 chambers

Reversing switches

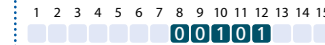
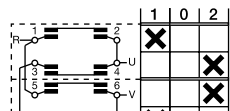
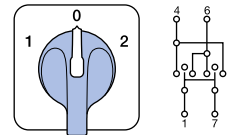

**101**  
2 poles  
2 chambers

Reversing switches

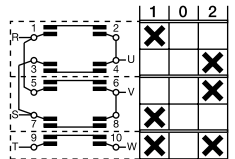
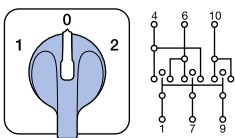

**102**  
3 poles  
3 chambers

Reversing switches with spring return

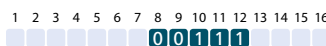
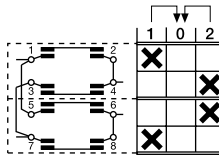
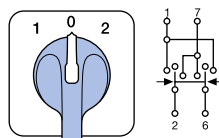

**111**  
2 poles  
2 chambers

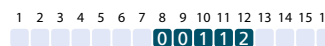
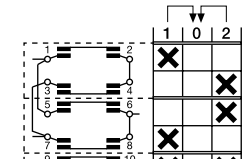
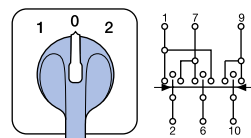

**112**  
3 poles  
3 chambers

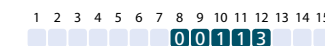
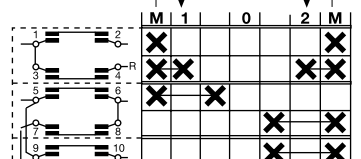
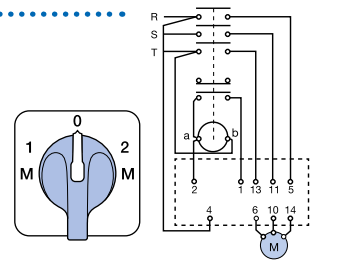

**113**  
3 poles for use with reserving  
contactors  
4 chambers

### Control switches with spring return

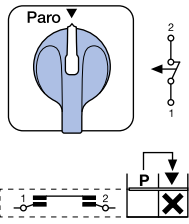

1 2 3 4 5 6 7 8 9 10 11 12 13 14 15 16  
002001

**201**  
Start switch 1 pole  
1 chamber

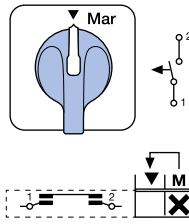

1 2 3 4 5 6 7 8 9 10 11 12 13 14 15 16  
002002

**202**  
Stop switch 1 pole  
1 chamber

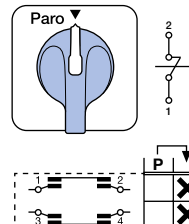

1 2 3 4 5 6 7 8 9 10 11 12 13 14 15 16  
002003

**203**  
Start switch 2 poles  
1 chamber

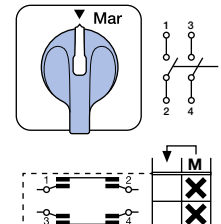

1 2 3 4 5 6 7 8 9 10 11 12 13 14 15 16  
002004

**204**  
Stop switch 2 poles  
1 chamber

### Stop-Start switches

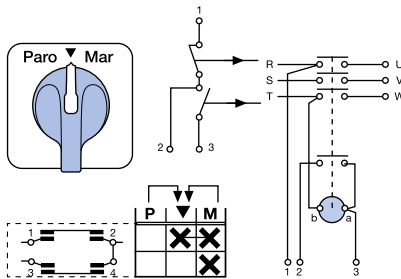

1 2 3 4 5 6 7 8 9 10 11 12 13 14 15 16  
002005

**205**  
With contactor  
1 chamber

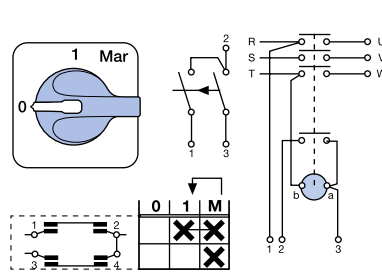

1 2 3 4 5 6 7 8 9 10 11 12 13 14 15 16  
002006

**206**  
With contactor and spring return  
1 chamber

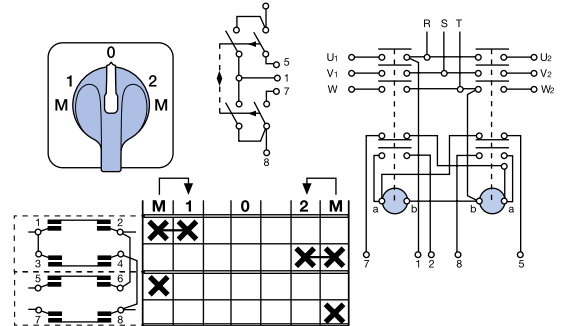

1 2 3 4 5 6 7 8 9 10 11 12 13 14 15 16  
002007

**207**  
With spring return to run for 2 units  
2 chambers

### Star delta switches

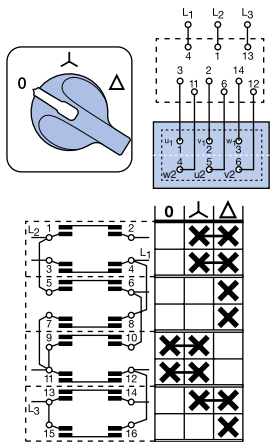

1 2 3 4 5 6 7 8 9 10 11 12 13 14 15 16  
003000

**300**  
Normal type  
4 chambers

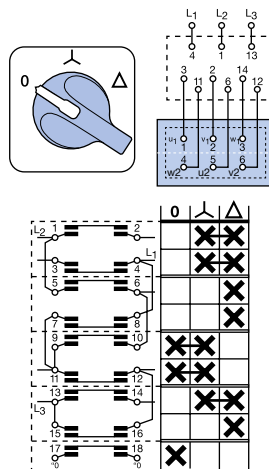

1 2 3 4 5 6 7 8 9 10 11 12 13 14 15 16  
003001

**301**  
Auxiliary contact closed in "0"  
5 chambers

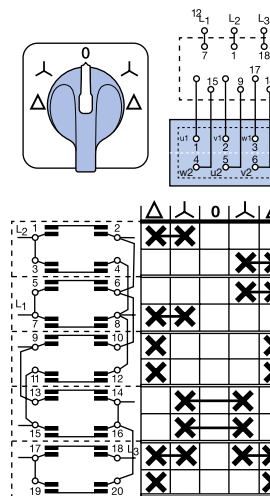

1 2 3 4 5 6 7 8 9 10 11 12 13 14 15 16  
003002

**302**  
Reversing  
5 chambers

**303**  
Rotary  
0 - λ - Δ - 0 - λ - Δ - 0  
5 chambers

**304**  
Position λ return to 0  
0 - λ - Δ  
4 chambers

**305**  
Reversing. Return from λ to 0  
Δ - λ - 0 - λ - Δ  
5 chambers

**308**  
Use with contactor  
0 - λ - Δ  
4 chambers

**309**  
Reversing for use with contactor  
Δ - λ - 0 - λ - Δ  
7 chambers

To view these wiring diagrams please visit our download area on [www.telergon.com](http://www.telergon.com)

Star delta switches

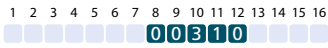
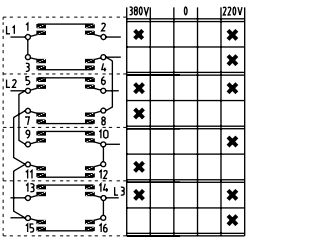
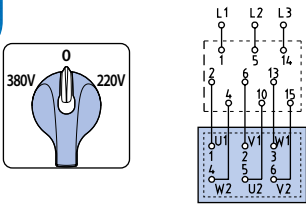

**310**  
Selector  $\lambda - \Delta$   
380 - 0 - 220  
4 chambers

Split phase starting switches

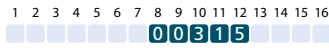
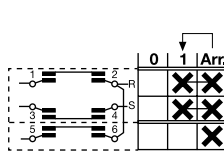
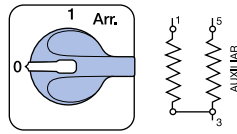

**315**  
Start return to 1  
2 chambers

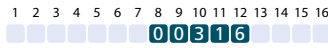
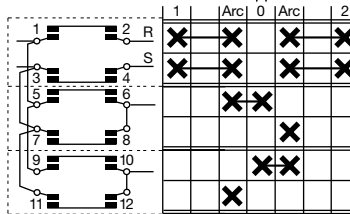
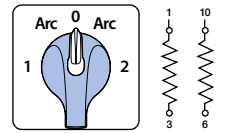

**316**  
Reversing type of T315  
1 - ARR - 0 - ARR - 2  
3 chambers

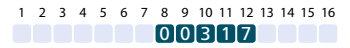
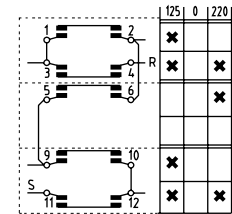
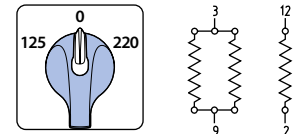

**317**  
Start single phase 2 voltages  
3 chambers

Dahlander multi-step switches

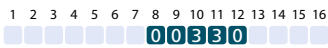
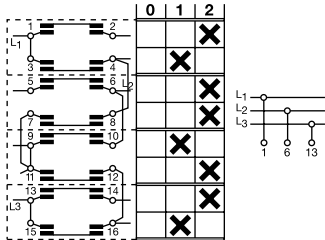
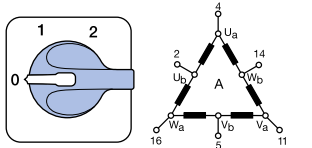

**330**  
Dahlander  $0 - \Delta_A - \lambda \lambda_A$   
4 chambers

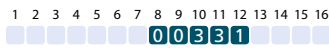
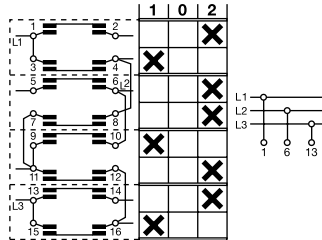
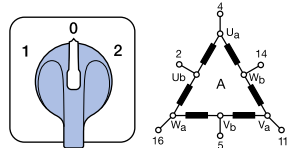

**331**  
Dahlander  $\Delta_A - 0 - \lambda \lambda_A$   
4 chambers

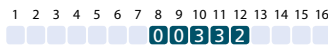
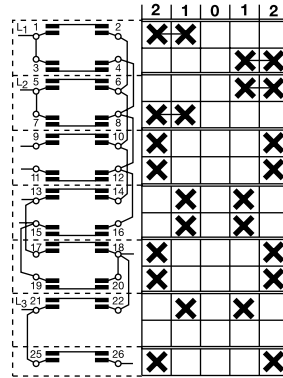
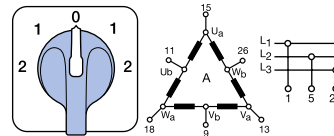

**332**  
Reversing type of T330  
7 chambers

**333**  
Dahlander  $0 - \Delta_A - \lambda \lambda_A - 0 - \Delta_A - \lambda \lambda_A - 0$   
0 - 1 - 2 - 0 - 1 - 2  
5 chambers

**334**  
For use with contactor  
0 - 1 - 2  
5 chambers

**335**  
Selector Dahlander  
 $0 - \lambda - \Delta_A - \lambda \lambda_A$   
6 chambers

**336**  
Reversing Dahlander  
 $\lambda \lambda_A - \Delta_A - \lambda - 0 - \lambda - \Delta_A - \lambda \lambda_A$   
2 - 1 -  $\lambda$  - 0 -  $\lambda$  - 1 - 2  
8 chambers

To view these wiring diagrams please visit our download area on [www.telergon.com](http://www.telergon.com)

Separate winding to speed

**340**  
 $0 - \lambda_A - \Delta - \lambda_B$   
 $0 - \lambda - 1 - 2$   
6 chambers

**341**  
 $0 - \Delta_A - \lambda_B$   
 $0 - 1 - 2$   
4 chambers

**342**  
 $0 - A - B$  en  $\lambda$  or  $\Delta$   
 $0 - 1 - 2$   
3 chambers

**343**  
Reversing del 342  
 $2 - 1 - 0 - 1 - 2$   
5 chambers

**344**  
 $\Delta_B - \lambda_B - 0 - \lambda_A - \Delta_A$   
 $1 - \lambda - 0 - \lambda - 2$   
8 chambers

**350**  
 $0 - \lambda_A - \Delta_B - \lambda \lambda_B$   
 $0 - 1 - 2 - 3$   
6 chambers

**351**  
Reversing type of T350  
 $3 - 2 - 1 - 0 - 1 - 2 - 3$   
9 chambers

To view these wiring diagrams please visit our download area on [www.telergon.com](http://www.telergon.com)

### Changeover switches with center "Off"

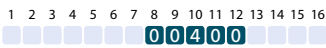
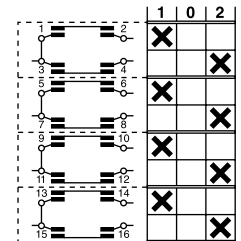
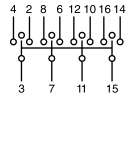
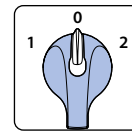
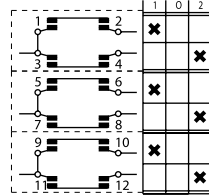
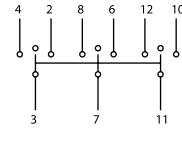
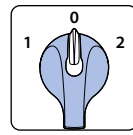
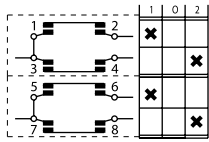
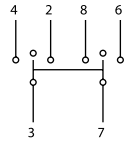
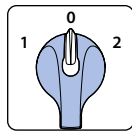
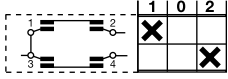
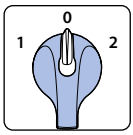

**400**  
1 pole  
1 chamber

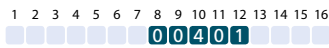

**401**  
2 poles  
2 chambers

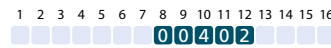

**402**  
3 poles  
3 chambers

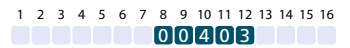

**403**  
4 poles  
4 chambers

	Poles	Positions	Chambers
400/5	5	3	5
400/6	6	3	6

	Poles	Positions	Chambers
400/7	7	3	7
400/8	8	3	8

	Poles	Positions	Chambers
400/9	9	3	9
400/10	10	3	10

	Poles	Positions	Chambers
400/11	11	3	11
400/12	12	3	12

To view these wiring diagrams please visit our download area on [www.telergon.com](http://www.telergon.com)

### Changeover switches with spring return to center

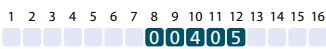
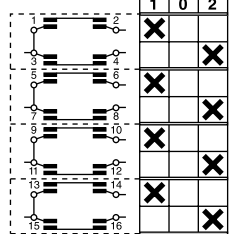
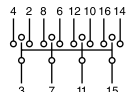
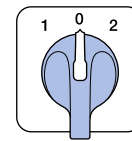
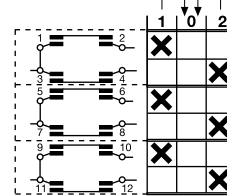
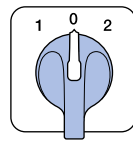
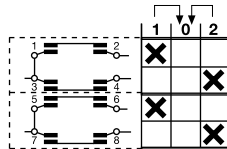
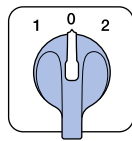
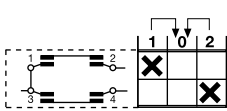
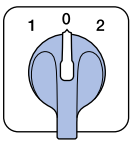

**405**  
1 pole  
1 chamber

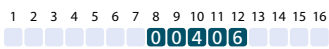

**406**  
2 poles  
2 chambers

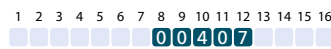

**407**  
3 poles  
3 chambers

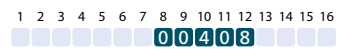

**408**  
4 poles  
4 chambers

### Multi-step switches with "Off" position

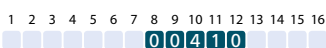
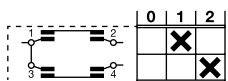
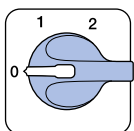

**410**  
1 pole 2 positions  
1 chamber

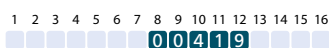
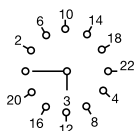
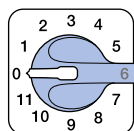

**419**  
1 pole 11 positions  
6 chambers

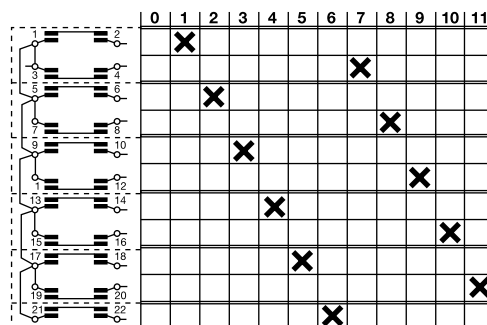

Multi-step switches with "Off" position

	Poles	Positions	Chambers		Poles	Positions	Chambers		Poles	Positions	Chambers		Poles	Positions	Chambers
411	1	3	2	422	2	4	4	432	3	4	6	452	5	4	10
412	1	4	2	423	2	5	5	433	3	5	9	460	6	2	6
413	1	5	3	424	2	6	7	434	3	6	12	461	6	3	9
414	1	6	4	425	2	7	8	435	3	7	12	462	6	4	12
415	1	7	4	426	2	8	9	440	4	2	4	470	7	2	7
416	1	8	5	427	2	9	10	441	4	3	6	471	7	3	11
417	1	9	5	428	2	10	11	442	4	4	8	480	8	2	8
418	1	10	6	429	2	11	12	443	4	5	10	481	8	3	12
420	2	2	2	430	3	2	3	450	5	2	5	490	9	2	9
421	2	3	3	431	3	3	5	451	5	3	8				

To view these wiring diagrams please visit our download area on [www.telergon.com](http://www.telergon.com)

Changeover switches without "Off"

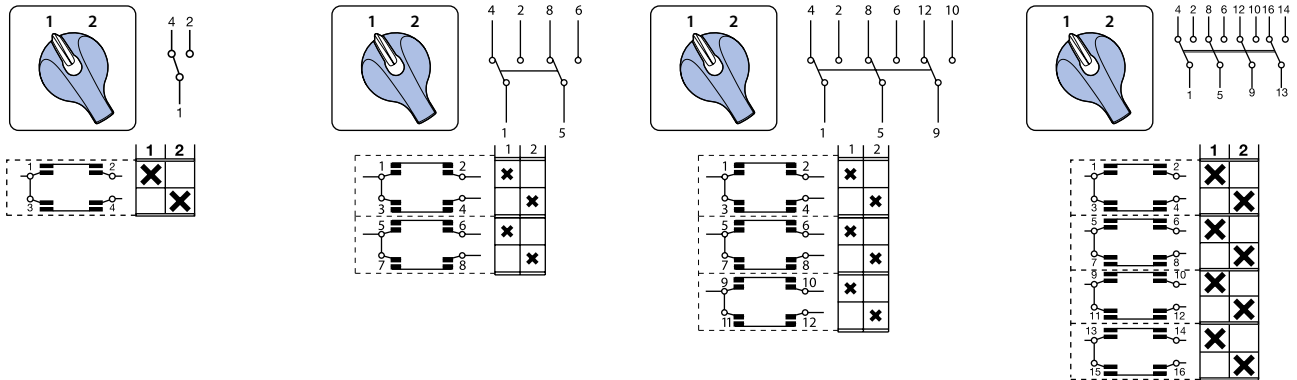

1 2 3 4 5 6 7 8 9 10 11 12 13 14 15 16	1 2 3 4 5 6 7 8 9 10 11 12 13 14 15 16	1 2 3 4 5 6 7 8 9 10 11 12 13 14 15 16	1 2 3 4 5 6 7 8 9 10 11 12 13 14 15 16
00500	00501	00502	00503
<b>500</b> 1 pole 1 chamber	<b>501</b> 2 poles 2 chambers	<b>502</b> 3 poles 3 chambers	<b>503</b> 4 poles 4 chambers

	Poles	Positions	Chambers		Poles	Positions	Chambers		Poles	Positions	Chambers		Poles	Positions	Chambers
500/5	5	2	5	500/7	7	2	7	500/9	9	2	9	500/11	11	2	11
500/6	6	2	6	500/8	8	2	8	500/10	10	2	10	500/12	12	2	12

To view these wiring diagrams please visit our download area on [www.telergon.com](http://www.telergon.com)

Multi-step switches without "Off" position

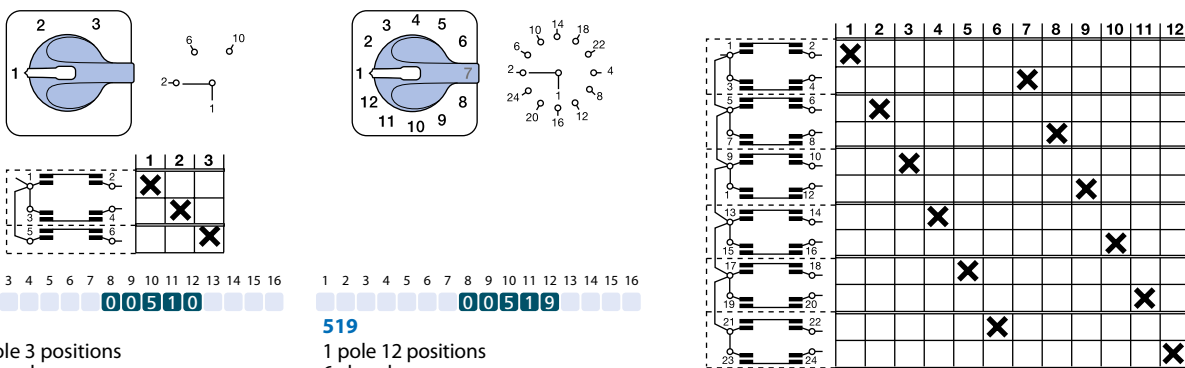

1 2 3 4 5 6 7 8 9 10 11 12 13 14 15 16	1 2 3 4 5 6 7 8 9 10 11 12 13 14 15 16
00510	00519
<b>510</b> 1 pole 3 positions 2 chambers	<b>519</b> 1 pole 12 positions 6 chambers

## Multi-step switches without "Off" position

	Poles	Positions	Chambers		Poles	Positions	Chambers		Poles	Positions	Chambers		Poles	Positions	Chambers
511	1	4	2	521	2	4	4	530	3	3	5	543	4	6	12
512	1	5	3	522	2	5	5	531	3	4	6	550	5	3	8
513	1	6	3	523	2	6	6	532	3	5	8	551	5	4	10
514	1	7	4	524	2	7	7	533	3	6	9	552	5	5	13
515	1	8	4	525	2	8	8	534	3	7	11	560	6	3	9
516	1	9	5	526	2	9	9	535	3	8	12	561	6	4	12
517	1	10	5	527	2	10	10	540	4	3	6	570	7	3	11
518	1	11	6	528	2	11	11	541	4	4	8	580	8	3	12
520	2	3	3	529	2	12	12	542	4	5	10				

To view these wiring diagrams please visit our download area on [www.telergon.com](http://www.telergon.com)

## Gang switches

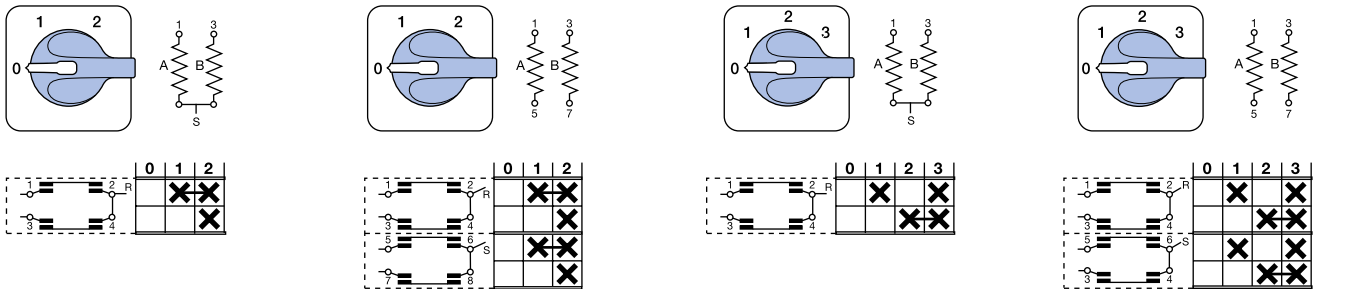

1 2 3 4 5 6 7 8 9 10 11 12 13 14 15 16  
00601

**601**  
1 pole switching sequence  
0 - A - (A+B)  
1 chamber

1 2 3 4 5 6 7 8 9 10 11 12 13 14 15 16  
00602

**602**  
2 poles switching sequence  
0 - A - (A+B)  
2 chambers

1 2 3 4 5 6 7 8 9 10 11 12 13 14 15 16  
00603

**603**  
1 pole switching sequence  
0 - A - B - (A+B)  
1 chamber

1 2 3 4 5 6 7 8 9 10 11 12 13 14 15 16  
00604

**604**  
2 poles switching sequence  
0 - A - B - (A+B)  
2 chambers

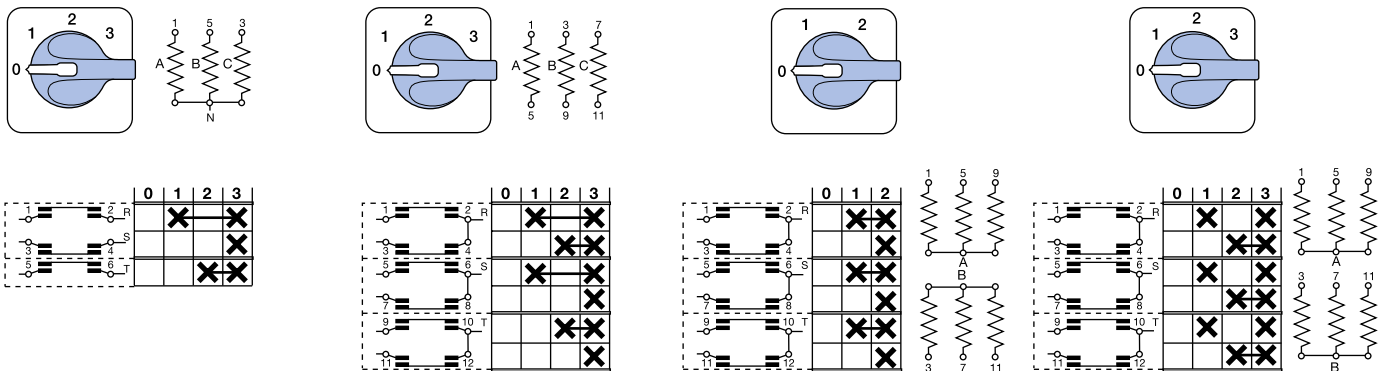

1 2 3 4 5 6 7 8 9 10 11 12 13 14 15 16  
00605

**605**  
1 pole switching sequence  
0 - A - (A+B) - (A+B+C)  
2 chambers

1 2 3 4 5 6 7 8 9 10 11 12 13 14 15 16  
00606

**606**  
2 poles switching sequence  
0 - A - (A+B) - (A+B+C)  
3 chambers

1 2 3 4 5 6 7 8 9 10 11 12 13 14 15 16  
00607

**607**  
3 poles switching sequence  
0 - A - (A+B)  
3 chambers

1 2 3 4 5 6 7 8 9 10 11 12 13 14 15 16  
00608

**608**  
3 poles switching sequence  
0 - A - B - (A+B)  
3 chambers

Gang switches

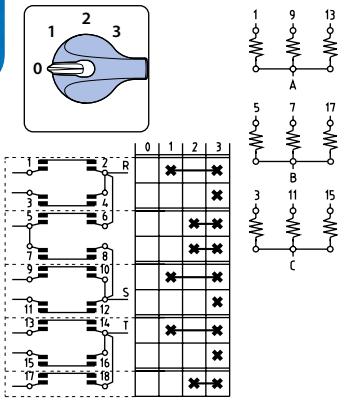

1 2 3 4 5 6 7 8 9 10 11 12 13 14 15 16  
00609

**609**  
3 poles switching sequence  
0 - A - (A+B) - (A+B+C)  
5 chambers

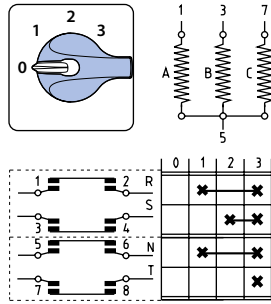

1 2 3 4 5 6 7 8 9 10 11 12 13 14 15 16  
00610

**610**  
Switching sequence  
 $\lambda$  0 - A - (A+B) - (A+B+C)  
2 chambers

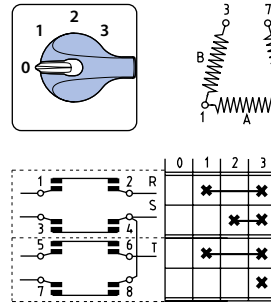

1 2 3 4 5 6 7 8 9 10 11 12 13 14 15 16  
00611

**611**  
Switching sequence  
 $\Delta$  0 - A - (A+B) - (A+B+C)  
2 chambers

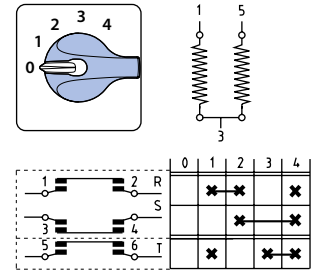

1 2 3 4 5 6 7 8 9 10 11 12 13 14 15 16  
00612

**612**  
Switching sequence 0 - A + B series  
A - B - (A + B) parallell  
2 chambers

Kitchen and heating switches

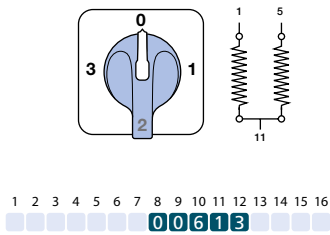

1 2 3 4 5 6 7 8 9 10 11 12 13 14 15 16  
00613

**613**  
3 positions switching sequence  
0-A+B parallell; A or B-A+B series - 0  
3 chambers

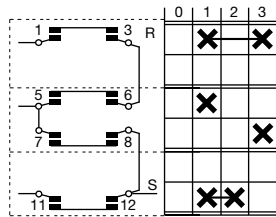

1 2 3 4 5 6 7 8 9 10 11 12 13 14 15 16  
00614

**614**  
3 positions switching sequence  
0-A+B series; A or B-A+B parallell  
2 chambers

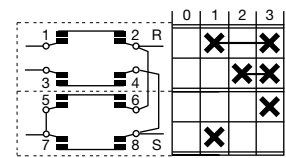

Resistance elimination switches

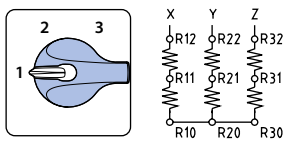

1 2 3 4 5 6 7 8 9 10 11 12 13 14 15 16  
00620

**620**  
3 phases, 3 points  
2 chambers

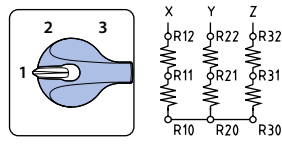

1 2 3 4 5 6 7 8 9 10 11 12 13 14 15 16  
00621

**621**  
3 phases, 3 points  
3 chambers  
With auxiliary contact

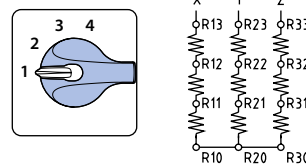

1 2 3 4 5 6 7 8 9 10 11 12 13 14 15 16  
00622

**622**  
3 phases, 4 points  
3 chambers

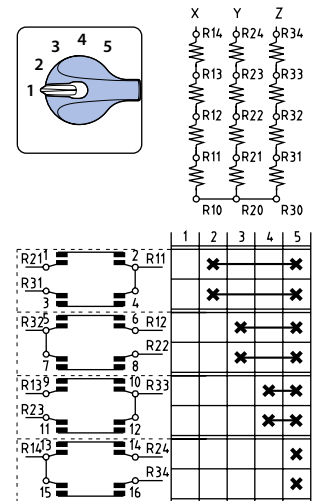

1 2 3 4 5 6 7 8 9 10 11 12 13 14 15 16  
00624

**624**  
3 phases, 5 points  
4 chambers

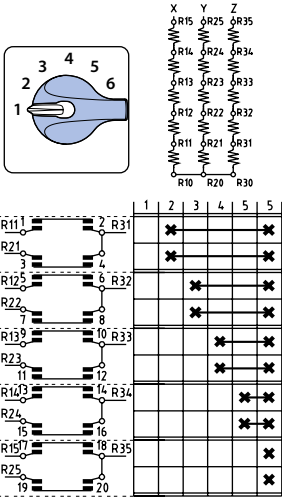

1 2 3 4 5 6 7 8 9 10 11 12 13 14 15 16  
**00626**  
**626**  
 3 phases, 6 points  
 5 chambers

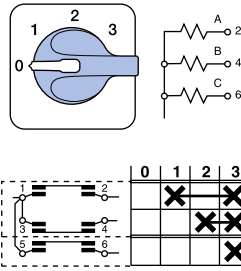

1 2 3 4 5 6 7 8 9 10 11 12 13 14 15 16  
**00630**  
**630**  
 Switching sequence  
 0 - A - (A+B) - (A+B+C)  
 2 chambers

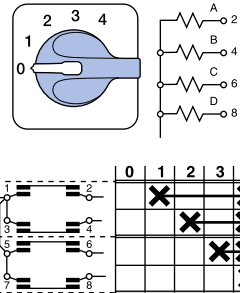

1 2 3 4 5 6 7 8 9 10 11 12 13 14 15 16  
**00631**  
**631**  
 Switching sequence  
 0 - A - (A+B) - (A+B+C) - (A+B+C+D)  
 2 chambers

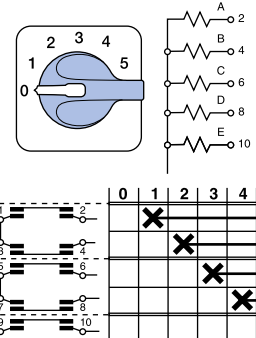

1 2 3 4 5 6 7 8 9 10 11 12 13 14 15 16  
**00632**  
**632**  
 Switching sequence  
 0 - A - (A+B) - (A+B+C) - (A+B+C+D) - (A+B+C+D+E)  
 3 chambers

**Voltmeter switches**

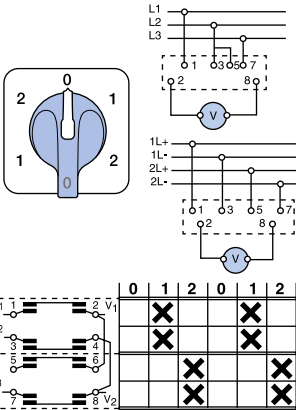

1 2 3 4 5 6 7 8 9 10 11 12 13 14 15 16  
**00700**  
**700**  
 2 phases C.A. or 2 poles C.C.  
 2 chambers

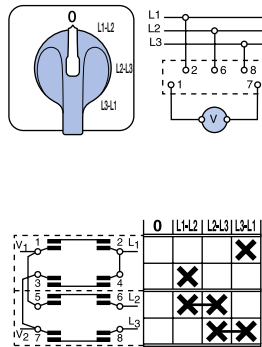

1 2 3 4 5 6 7 8 9 10 11 12 13 14 15 16  
**00701**  
**701**  
 3 phases  
 2 chambers

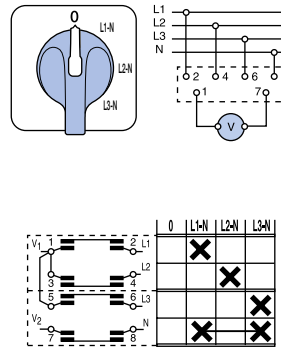

1 2 3 4 5 6 7 8 9 10 11 12 13 14 15 16  
**00702**  
**702**  
 3 phases to neutral  
 2 chambers

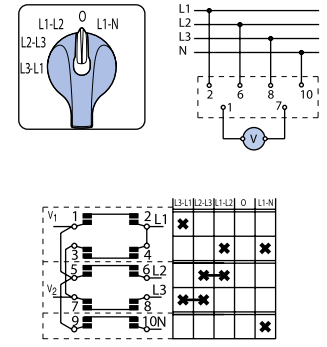

1 2 3 4 5 6 7 8 9 10 11 12 13 14 15 16  
**00704**  
**704**  
 3 phases and 1 phase to neutral  
 3 chambers

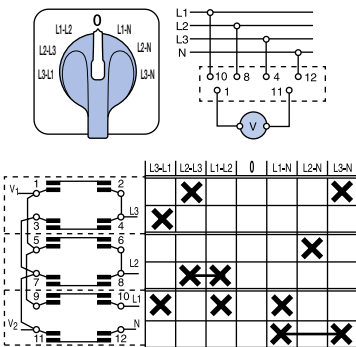

1 2 3 4 5 6 7 8 9 10 11 12 13 14 15 16  
**00705**  
**705**  
 3 phases to phase and 3 phases to neutral  
 3 chambers

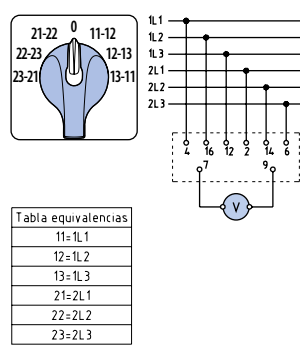

1 2 3 4 5 6 7 8 9 10 11 12 13 14 15 16  
**00706**  
**706**  
 2 three-phase lines (phase to phase)  
 4 chambers/chambers

Tabla equivalencias

11=	1L1
12=	1L2
13=	1L3
21=	2L1
22=	2L2
23=	2L3

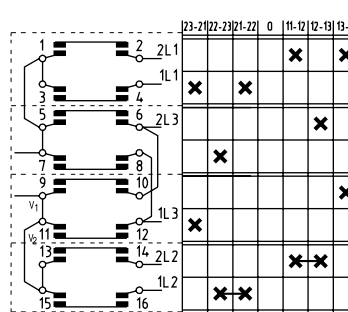

**703**  
 4 lines with 2 wires C.A. o C.C.  
 4 chambers

**708**  
 3 phases, 2 potential transformers  
 1 pole  
 2 chambers

To view these wiring diagrams please visit our download area on [www.telergon.com](http://www.telergon.com)

**Ammeter switches**

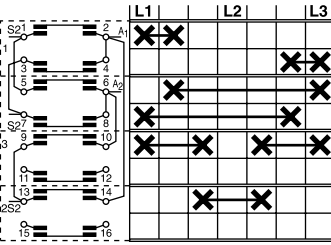
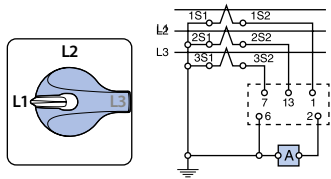

1 2 3 4 5 6 7 8 9 10 11 12 13 14 15 16  
00720

**720\***  
3 phases, 3 current transformers,  
1 pole  
4 chambers

\* New diagram 732

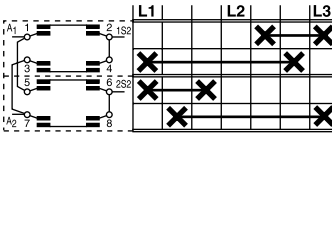
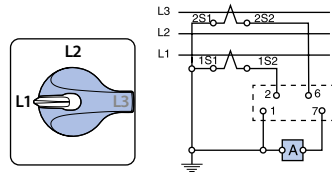

1 2 3 4 5 6 7 8 9 10 11 12 13 14 15 16  
00721

**721**  
3 phases, 2 current transformers,  
1 pole  
2 chambers

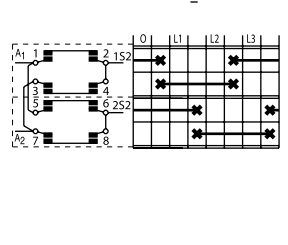
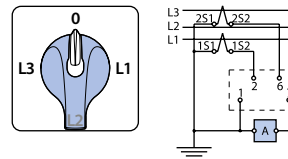

1 2 3 4 5 6 7 8 9 10 11 12 13 14 15 16  
00724

**724**  
3 phases, 2 current transformers,  
1 pole  
2 chambers

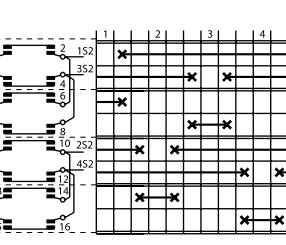
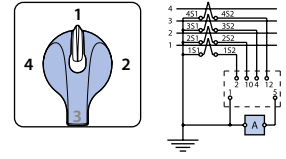

1 2 3 4 5 6 7 8 9 10 11 12 13 14 15 16  
00725

**725**  
4 lines, 4 current transformers,  
1 pole  
4 chambers

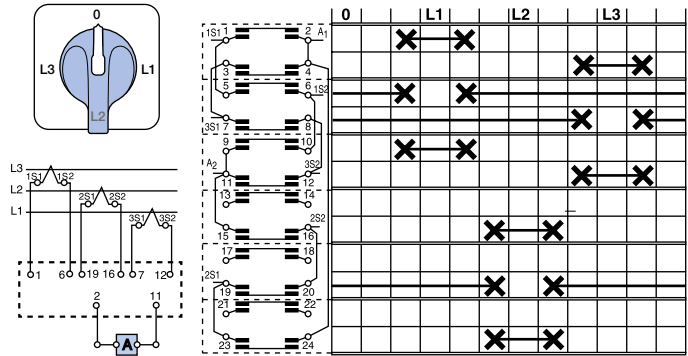

1 2 3 4 5 6 7 8 9 10 11 12 13 14 15 16  
00727

**727**  
3 lines, 3 current transformers,  
2 poles  
6 chambers

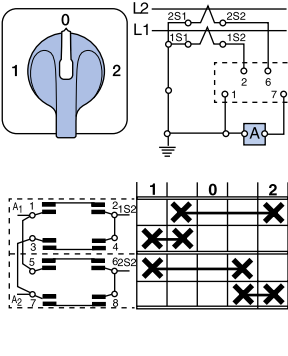

1 2 3 4 5 6 7 8 9 10 11 12 13 14 15 16  
00730

**730**  
2 current transformers,  
1 pole  
2 chambers

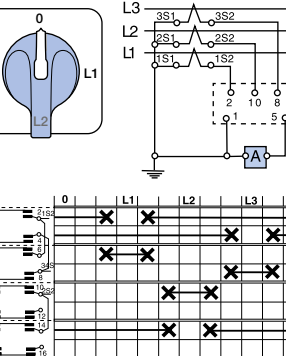

1 2 3 4 5 6 7 8 9 10 11 12 13 14 15 16  
00731

**731\***  
3 current transformers,  
1 pole  
4 chambers

\* New diagram 733

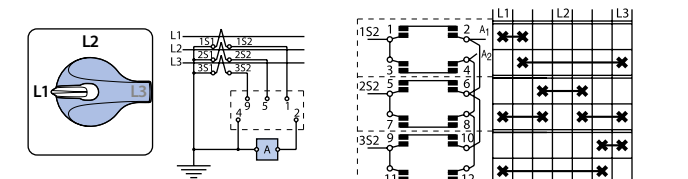

1 2 3 4 5 6 7 8 9 10 11 12 13 14 15 16  
00732

**732**  
3 phases, 3 current transformers,  
1 pole  
3 chambers

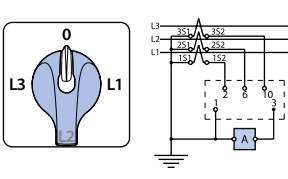

1 2 3 4 5 6 7 8 9 10 11 12 13 14 15 16  
00733

**733**  
3 lines, 3 current transformers,  
1 pole  
3 chambers

**722**  
3 phases, 2 or 3 current transformers,  
1 pole  
5 chambers

**723**  
2 lines, 2 current transformers,  
1 pole  
3 chambers

**729**  
1 current transformers,  
1 pole  
1 chamber

**726**  
2 lines, 2 current transformers,  
2 poles  
3 chambers

**728**  
4 lines, 4 current transformers,  
2 poles  
6 chambers

To view these wiring diagrams please visit our download area on [www.telergon.com](http://www.telergon.com)

Switches for B.C.D. codification with "Off"

**0BCD3**  
3 positions  
1 chamber

**0BCD11**  
11 positions  
2 chambers

Switches for B.C.D. codification without "Off"

**1BCD3**  
3 positions  
1 chamber

**1BCD12**  
12 positions  
2 chambers

**1BCD4**  
4 positions  
2 chambers

**1BCD6**  
6 positions  
2 chambers

**1BCD8**  
8 positions  
2 chambers

**1BCD10**  
10 positions  
2 chambers

- 0BCD4**  
4 positions  
2 chambers
- 0BCD5**  
5 positions  
2 chambers
- 0BCD6**  
6 positions  
2 chambers
- 0BCD7**  
7 positions  
2 chambers
- 0BCD8**  
8 positions  
2 chambers
- 0BCD9**  
9 positions  
2 chambers
- 0BCD10**  
10 positions  
2 chambers

- 1BCD4**  
4 positions  
2 chambers
- 1BCD5**  
5 positions  
2 chambers
- 1BCD6**  
6 positions  
2 chambers
- 1BCD7**  
7 positions  
2 chambers
- 1BCD8**  
8 positions  
2 chambers
- 1BCD9**  
9 positions  
2 chambers
- 1BCD10**  
10 positions  
2 chambers
- 1BCD11**  
11 positions  
2 chambers

To view these wiring diagrams please visit our download area on [www.telergon.com](http://www.telergon.com)

By-pass switches

**800**  
2 poles  
3 chambers

**801**  
3 poles  
5 chambers

**802**  
3 poles + N  
6 chambers

**820**  
2 poles  
3 chambers

**821**  
3 poles  
5 chambers

**822**  
3 poles + N  
6 chambers

A	L1	L2	L3	N
B	1	5	13	17
C	2	6	14	18
D	7	11	19	23
E	4	10	16	22
F	1	5	13	17
G	4	10	16	22

# T Door mounting **E**

series **T**

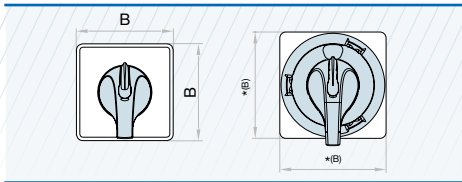

Door mounting drilling

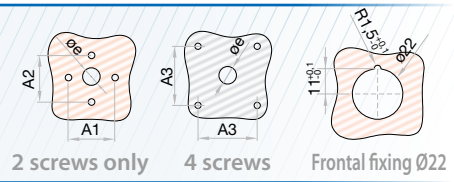

\*B) Features & dimensions in page 27.

Note:  
The cam switches allow a construction up to 12 chambers (24 contacts).  
It's necessary to distribute in several columns (maximum three of 12 chambers each) when the number of contacts is higher than 24, so we use the tandem drives D200 or D201.  
Depending on the number of contacts to be switched simultaneously, it's possible to supply up to 14 chambers switches in size 0.

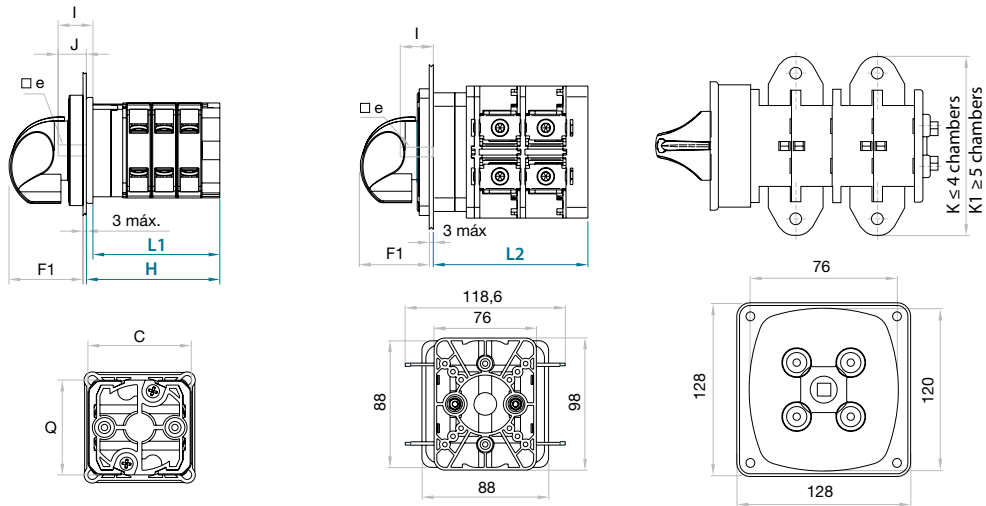

Size	Series	A1	øA1	A2	øA2	A3	øA3	B	C	øe	□e	Q	F1	I	J	K	K1
0	T12 T20	32	4,5	-	4,5	36	4,5	50	46,5	12	5	46	33,5	18	15	-	-
1	T16 25	45	4,5	-	4,5	48	4,5	65	60,5	12	5	57,5	36	20	16,8	-	-
	T32 T40											64,5					
2	T50 T63 T80	-	-	60	5,5	68	5,5	94	66	12	7	80	45	24,5	20,5	-	-
	T100 T125								84,5								
3	T175	-	-	60	5,5	68	5,5	94	-	12	7	-	45	24,5	-	-	-
	T200 T250 T315								150								
	T400 T500	-	-	-	-	108	6,5	128	76	16	10	120	67	-	40	176	-
	T630 T800	-	-	-	-	-	-	-	-	-	-	-	-	-	-	218	256

Size	Series	Chambers														
		1□	2□	3□	4□	5□	6□	7□	8□	9□	10□	11□	12□	13□	14□	
0	T12 T20	L1	34,5	46	57,5	69	80,5	92	103,5	115	126,5	138	149,5	161	172,5	184
		H	37,5	49	60,5	72	83,5	95	106,5	118	129,5	141	152,5	164	175,5	187
1	T16 T25	L1	46,4	60,6	74,8	89	103,2	117,4	131,6	145,8	160	174,2	188,4	202,6	*(1)	*(1)
		H	49,6	63,8	78	92,2	106,4	120,6	134,8	149	163,2	177,4	191,6	205,8	*(1)	*(1)
	T32 T40	L1	49,8	67,3	84,8	102,3	119,8	137,3	154,8	172,3	189,8	207,3	224,8	242,3	*(1)	*(1)
		H	53	70,5	88	105,5	123	140,5	158	175,5	193	210,5	228	245,5	*(1)	*(1)
2	T50 T63 T80	L1	58,5	78,5	98,5	118,5	138,5	158,5	178,5	198,5	218,5	238,5	258,5	278,5	*(1)	*(1)
		H	62,5	82,5	102,5	122,5	142,5	162,5	182,5	202,5	222,5	242,5	262,5	282,5	*(1)	*(1)
	T100 T125	L1	67	94	121	147,5	174	201	227,5	254	281	307,5	334	361	*(1)	*(1)
		L2	71	98	125	151,5	178	205	231,5	258	285	311,5	338	365	*(1)	*(1)
	T175	L2	80,8	114,8	148,8	182,8	216,8	250,8	284,8	318,8	352,8	386,8	420,8	454,8	*(1)	*(1)
		H	95	135	175	215	255	295	335	375	415	455	495	535	*(1)	*(1)
3	T200 T250 T315	H	135	215	295	375	455	535	*(1)	*(1)	*(1)	*(1)	*(1)	*(1)	*(1)	*(1)
		H	175	295	415	535	*(1)	*(1)	*(1)	*(1)	*(1)	*(1)	*(1)	*(1)	*(1)	*(1)
	T400 T500	H	175	295	415	535	*(1)	*(1)	*(1)	*(1)	*(1)	*(1)	*(1)	*(1)	*(1)	*(1)
		H	215	375	535	*(1)	*(1)	*(1)	*(1)	*(1)	*(1)	*(1)	*(1)	*(1)	*(1)	*(1)

\*(1) Tandem drive D200/D201- Features & dimensions in page 24.

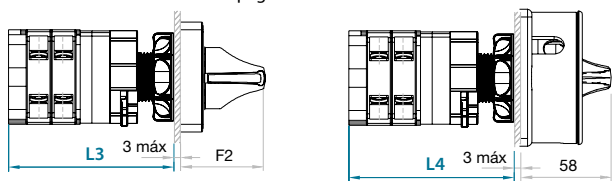

Size	Series	Chambers *(ch)							
		1□	2□	3□	4□	5□	6□	F2	
0	T12 T20	L3	63,5	75	86,5	98	109,5	121	53,5
1	T16 T25	L4	75,5	89,5	103,8	118	-	-	55,5
		L4	78,8	96,3	116,8	131,3	-	-	55,5

\*(ch) Central quick fixing ø22 - maximum number of chambers supported.

## TB Door mounting

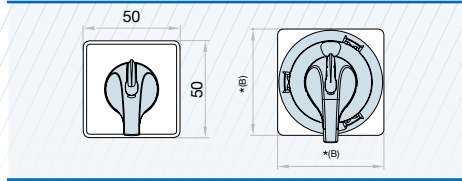

Door mounting drilling

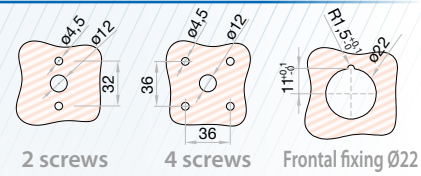

\*1(B) Features & dimensions in page 27.

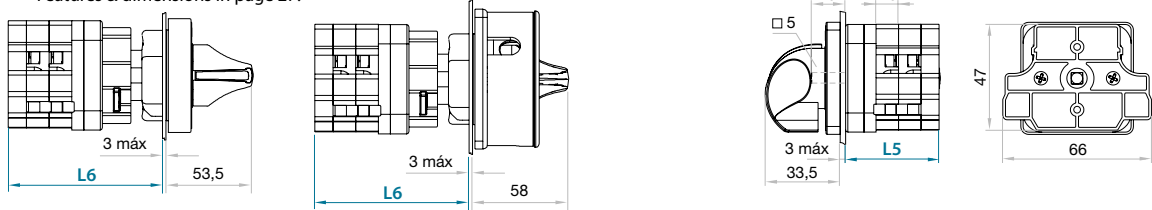

	Chambers											
	1□	2□	3□	4□	5□	6□	7□	8□	9□	10□	11□	12□
L5	31,5	41,5	51,5	61,5	71,5	81,5	91,5	101,5	111,5	121,5	131,5	141,5
L6	60,5	70,5	80,5	90,5	100,5	110,5	-	-	-	-	-	-

## TF Door mounting

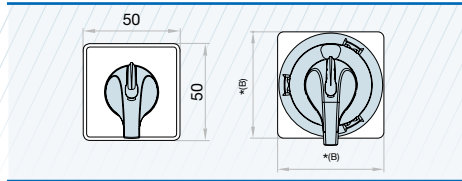

Door mounting drilling

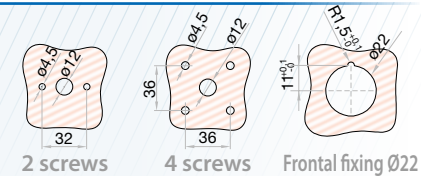

\*1(B) Features & dimensions in page 27.

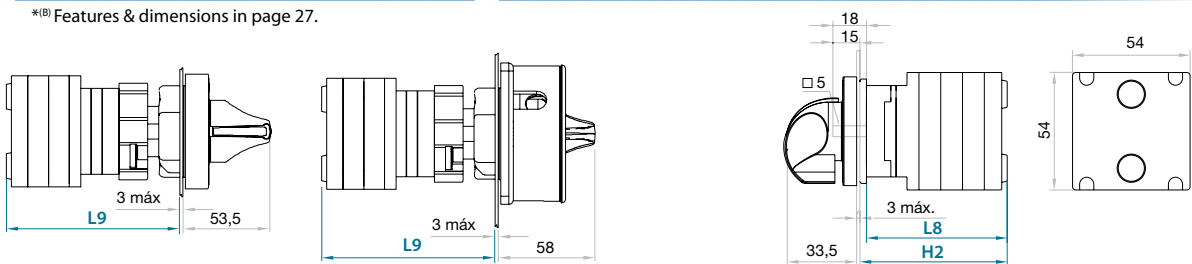

	Chambers											
	1□	2□	3□	4□	5□	6□	7□	8□	9□	10□	11□	12□
L8	45	55	65	75	85	95	105	115	125	135	145	155
L9	73,5	83,5	93,5	103,5	113,5	123,5	-	-	-	-	-	-
H2	48	58	68	78	88	98	108	118	128	138	148	158

## TP Door mounting

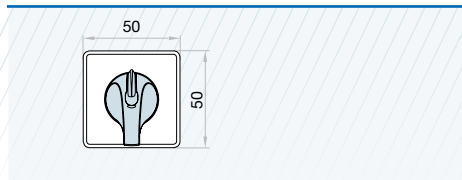

Door mounting drilling

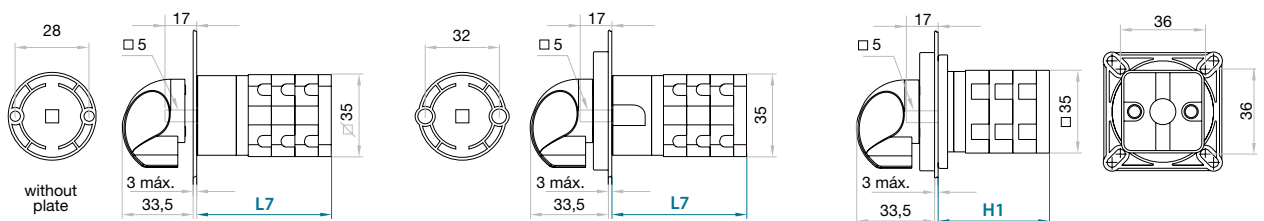
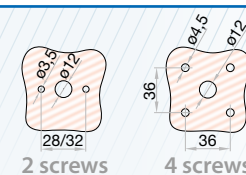

	Chambers											
	1□	2□	3□	4□	5□	6□	7□	8□	9□	10□	11□	12□
L7	37,5	47	56,5	66	75,5	85	94,5	104	113,5	123	132,5	142
H1	26,5	36	45,5	55	64,5	74	83,5	93	102,5	112	121,5	131

# T Base mounting with clutch device

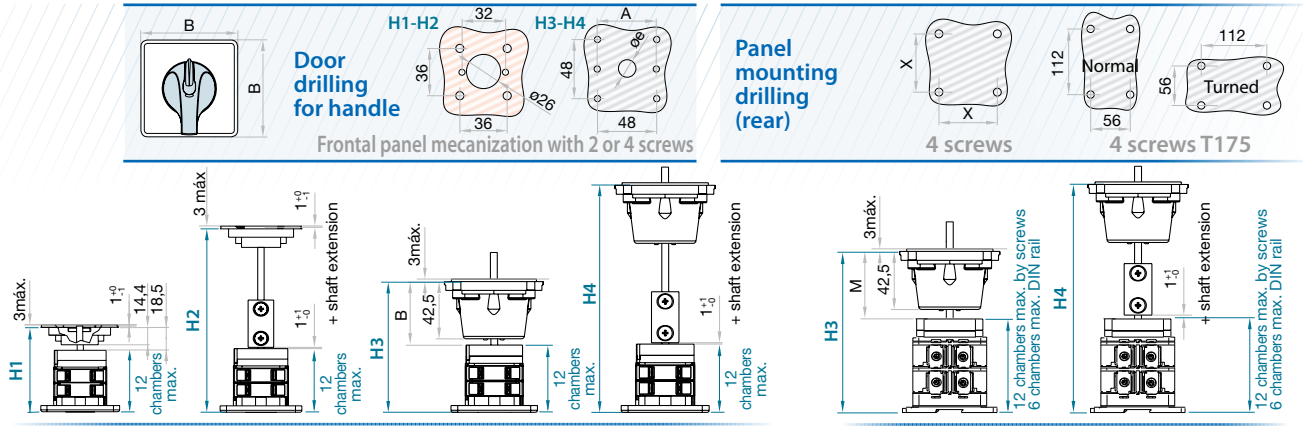

Size	Series		Chambers				A	B	øe	M	X			
			H1	H2	H3	H4								
0	T12 T20	min	56	+11,5	94	+11,5	121	32	50	12	45,5	43		
		max	-	-	256	-	283	-	-	-	-	-	-	
1	T16 T25	min	-	-	-	97,1	+14,2	135,1	32	65	12	47,5	48	
		max	-	-	-	-	-	297,1	-	-	-	-	-	
	T32 T40	min	-	-	-	100,5	+17,5	138,5	32	65	12	47,5	48	
		max	-	-	-	-	-	300,5	-	-	-	-	-	
	T50 T63 T80	min	-	-	-	114,5	+20	152,5	60	94	12	52	68	
		max	-	-	-	-	-	314,5	-	-	-	-	-	
2	T100 T125	min	-	-	-	123	+27	161	60	94	12	52	68	
		max	-	-	-	-	-	323	-	-	-	-	-	
	T175	min	-	-	-	141,8	+34	179,8	60	94	12	52	-	
		max	-	-	-	-	-	341,8	-	-	-	-	-	
3	T200		-	-	-	162,5	+40	-	-	-	48	16	67,5	108

# TB Base mounting with clutch device

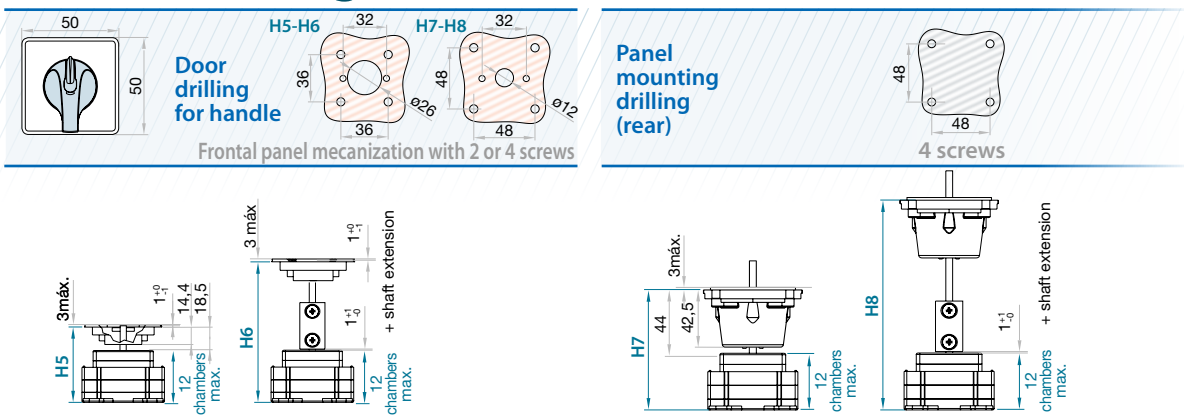

Size	Series		Chambers					
			H5	H6	H7	H8		
0	TB20 TB25 TB32	min	46	+10	84	+10	113	+10
		max	-	-	246	-	275,5	-

# TF Base mounting with clutch device

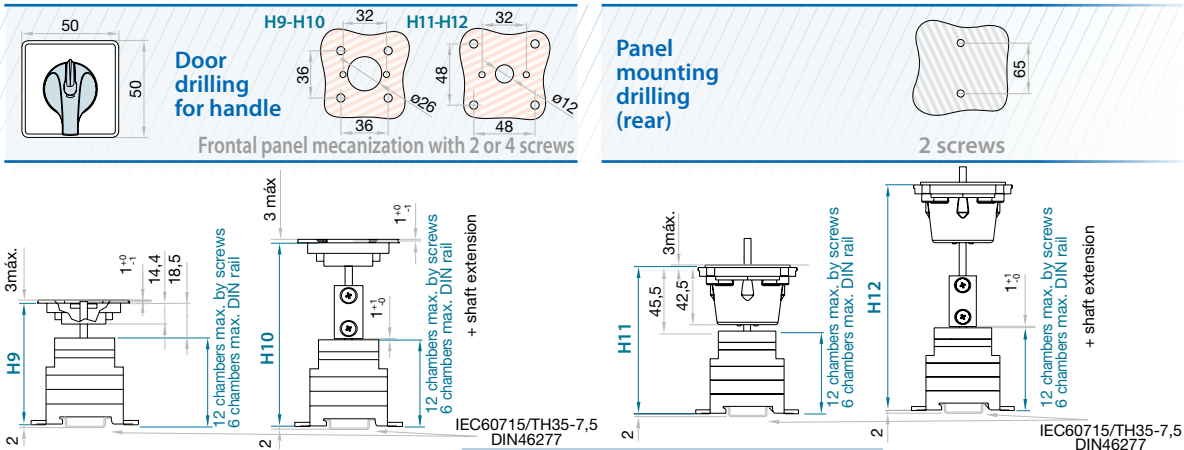

Size	Series		Chambers					
			H9	H10	H11	H12		
0	TF12 TF16 TF25	min	65,5	+10	103,5	+10	130,5	+10
		max	-	-	265,5	-	292,5	-

# T Base mounting with screws or DIN rail (direct handle) □

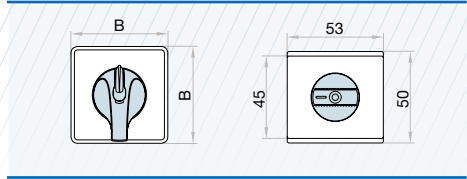

Panel mounting drilling (rear)

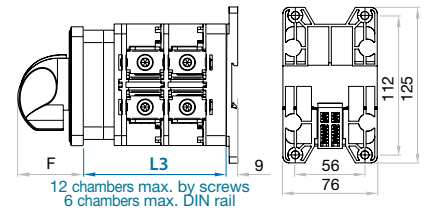
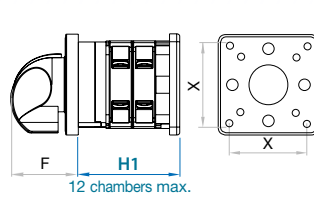
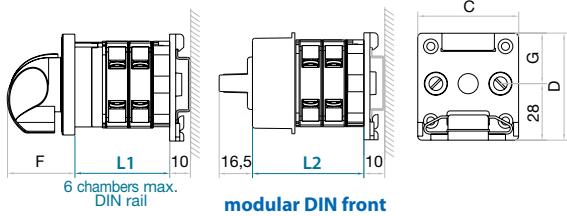
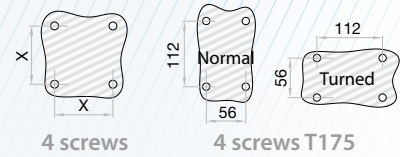

Size	Series		Chambers						+□	B	C	D	F	G	X	
			1□	2□	3□	4□	5□	6□								
0	T12 T20	L1	34,5	46	57,5	69	80,5	92	+11,5	50	50	53	33,5	25	-	
		L2	-	53,5	65	76,5 <sup>*(1)</sup>	-	-		-	-	50	53	-	25	-
		H1	37,5	49	60,5	72	83,5	95		50	-	-	33,5	-	43	-
1	T16 T25	L1	46,4	60,6	74,8	89	-	-	+14,2	65	50	53	36	25	-	
		H1	49,6	63,8	78	92,2	106,4	120,6		65	-	-	36	-	48	-
	T32 T40	L1	49,8	67,3	84,8	102,3	-	-	+17,5	65	-	-	36	-	-	
H1	53	70,5	88	105,5	123	140,5	65	-		-	36	-	48	-		
2	T50 T63 T80	H1	62,5	82,5	102,5	122,5	142,5	162,5	+20	94	-	-	45,5	-	68	
	T100 T125	H1	71	98	125	152	179	206	+27	94	-	-	45,5	-	68	
	T175	L3	80,8	114,8	148,8	-	-	-	+34	94	-	-	45,5	-	-	
3	T200	H1	95	135	175	215	255	295	+40	132	-	-	67	-	108	

<sup>\*(1)</sup> Modular enclosure 3 chambers max

# TB Base mounting with screws (direct handle) □

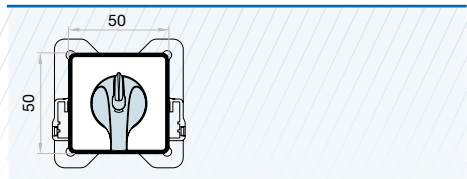

Panel mounting drilling (rear)

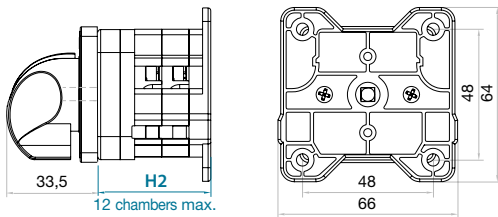

Chambers					
1□	2□	3□	4□	+□	
H2	31,5	41,5	51,5	61,5 <sup>*(2)</sup>	+10

<sup>\*(2)</sup> Modular enclosure 3 chambers max

# TF Base mounting with screws or DIN rail (direct handle) □

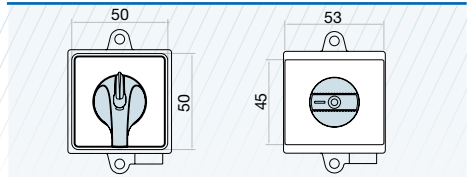

Panel mounting drilling (rear)

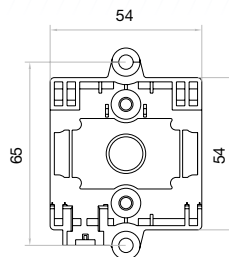
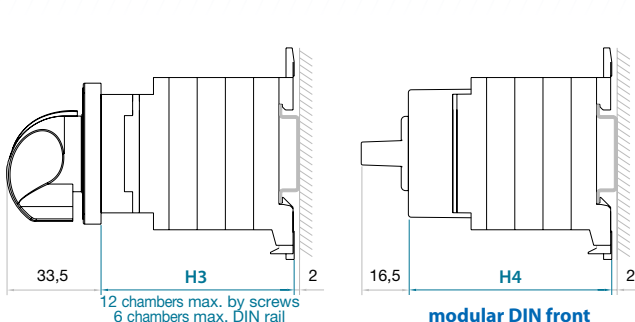
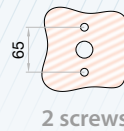

Chambers							
1□	2□	3□	4□	5□	6□	+□	
H3	50	60	70	80	90	100	+10
H4	52,5	62,5	72,5	82,5 <sup>*(3)</sup>	92,5 <sup>*(3)</sup>	-	-

<sup>\*(3)</sup> Modular enclosure 3 chambers max

## Technical specifications

According to IEC 60947-3			Size 0		Size 1				Size 2					Size 3									
			T12	T20	T16	T25	T32	T40	T50	T63	T80	T100	T125	T175	T200	T250	T315	T400	T630	T800	T1250	T1600	
Rated thermal current	I <sub>th</sub>	A	16	25	25	32	40	50	63	80	80	125	125	200	200	250	315	400	630	800	1000	1600	
Rated insulation voltage	U <sub>i</sub>	V	500	500	690	690	690	690	690	690	690	690	690	1000	690	690	690	690	690	690	690	690	
Rated impulse withstand voltage	U <sub>imp</sub>	kV	6	6	6	6	8	8	8	8	8	8	8	8	8	8	8	8	8	8	8	8	
			U <sub>e</sub>																				
AC rated operational current	I <sub>e</sub>	U <sub>e</sub> 415V AC21A	A	16	25	25	32	40	50	63	80	80	125	125	200	200	250	315	315	315	400	500	500
		U <sub>e</sub> 415V AC22A	A	16	25	25	32	40	50	63	80	80	115	115	200	200	250	315	250	315	315	315	400
		U <sub>e</sub> 415V AC23A	A	10	25	16	20	25	32	63	63	63	100	100	200	200	200	200	-	-	-	-	-
Rated conditional short-circuit current	I <sub>sc</sub>	kA	10	10	10	10	10	10	15	15	15	15	15	15 <sup>*(3)</sup>	15	15	15	15	10	10	10	10	
Rated maximum current	I <sub>g</sub> -gG	A	25	25	32	32	50	50	80	80	80	125	125	160	200	250	315	400	630	800	1000	2x800	
Rated breaking capacity	400V; cos φ=0,45	A	80	100	160	200	256	320	504	504	504	640	640	1600	1450	2000	2240	1450	1450	1450	1450	1450	
Rated short-time withstand current (1 sec)	I <sub>st</sub>	A	240	400	500	650	800	800	1600	1600	1600	2500	2500	3500	4400	4400	4400	6000	7000	7600	8000	8200	
Mechanical durability (according to the standards, for other values please consult)			10000	10000	10000	10000	10000	10000	10000	10000	10000	8000	8000	8000	8000	8000	8000	5000	5000	3000	3000	3000	
Maximum connection capacity																							
Rigid copper conductor		mm <sup>2</sup>	2x4	2x4	2x6	2x6	2x10	2x10	16/25 <sup>*(2)</sup>	16/25 <sup>*(2)</sup>	16/25 <sup>*(2)</sup>	35/50 <sup>*(2)</sup>	35/50 <sup>*(2)</sup>	95	95	120	185	-	-	-	-	-	
Flexible copper conductors		mm <sup>2</sup>	2x2,5	2x2,5	2x4	2x4	2x6	2x6	10/16 <sup>*(2)</sup>	10/16 <sup>*(2)</sup>	10/16 <sup>*(2)</sup>	16/35 <sup>*(2)</sup>	16/35 <sup>*(2)</sup>	95	95	120	185	-	-	-	-	-	

According to UL508 - CAN / CSA C22.2 N° 14			Size 0		Size 1				Size 2					Size 3									
			T12	T20	T16	T25	T32	T40	T50	T63	T80	T100	T125	T175	T200	T250	T315	T400	T630	T800	T1250	T1600	
Rated thermal current	I <sub>th</sub>	A	12	20	16	25	32	40	63	63	63	100	100	200	200	200	200	-	-	-	-	-	
General use rating			A	12	20	16	25	32	40	63	63	63	100	100	200	200	200	200	-	-	-	-	-
			Vac	300	300	600	600	600	600	600	600	600	600	600	600	600	600	600	600	-	-	-	-
AC rated operational power	I <sub>e</sub>	3x240V	HP	2	5	5	7,5	10	15	20	20	20	30	30	25	60	60	60	-	-	-	-	-
		3x480V	HP	-	-	10	15	20	25	40	40	40	50	50	60	75	75	75	-	-	-	-	-
		3x600V	HP	-	-	10	15	20	25	40	40	40	50	50	50	60	60	60	-	-	-	-	-

\*<sup>(1)</sup> 500V size "0" \*<sup>(2)</sup> With extension terminals \*<sup>(3)</sup> With phase barriers

Approvals T:



consult

### Normal service conditions\*

- Ambient air temperature (°C): -5°...+40°.
  - Maximum altitude: 2.000 m.
  - Maximum humidity: 90%.
  - Pollution degree: 3 (standard for industrial applications).
  - Rated frequency at AC utilization categories: 50/60 Hz.
  - Rated duties at utilization categories AC21A, AC22A y AC23A: Continuing (8 hours); uninterrupted.
  - Rated duties at utilization categories AC3 and AC4: Intermittent; temporary
  - Switching direct currents: For L/R<50msg, rated operational current (I<sub>e</sub>) can be dealt with up to 30Vdc. With higher voltages, several contacts have to be connected in series.
- \* Please consult for other service conditions.

According to IEC 60947-3			Size 0						
			TB20	TB25	TB32	TF12	TF16	TF25	
Rated thermal current	Ith	A	20	25	32	20	25	32	
Rated insulation voltage	Ui	V	500	500	500	690	690	690	
Rated impulse withstand voltage	Uimp	kV	4	4	4	6	6	6	
		Ue							
AC rated operational current	Ie	Ue 415V AC21A	A	20	25	32	20	25	32
		Ue 415V AC22A	A	20	25	32	20	25	32
		Ue 415V AC23A	A	20	25	32	-	-	-
Rated conditional short-circuit current		kA	5	5	5	5	5	5	
Rated maximum current	gL-gG	A	35	35	35	20	25	32	
Rated breaking capacity	400V; cos φ=0,45	A	160	200	256	100	160	200	
Rated short-time withstand current (1 sec)		A	240	400	500	350	400	500	
Mechanical durability (according to the standards, for other values please consult)			10000	10000	10000	10000	10000	10000	
Maximum connection capacity									
Rigid copper conductor		mm <sup>2</sup>	1x10 2x6	1x10 2x6	1x10 2x6	1x10	1x10	1x10	
Flexible copper conductors		mm <sup>2</sup>	1x6 2x4	1x6 2x4	1x6 2x4	1x6	1x6	1x6	

According to UL508 - CAN / CSA C22.2 N° 14			Size 0					
						TF12	TF16	TF25
Rated thermal current	Ith	A	-	-	-	16	20	25
General use rating		A	-	-	-	16	20	25
		Vac	-	-	-	600	600	600
AC rated operational power	3x240V	HP	-	-	-	2	5	7,5
	3x480V	HP	-	-	-	5	10	12
	3x600V	HP	-	-	-	5	10	15

According to IEC 60947-3 / IEC 60947-5				Size 0	
				TP10	
Rated thermal current	Ith	A	12		
Rated insulation voltage	Ui	V	500		
Rated impulse withstand voltage	Uimp	kV	4		
		Ue			
AC rated operational current	Ie	Ue 415V AC13A	A	10	
		Ue 415V AC21A	A	12	
		Ue 415V AC22A	A	12	
		Ue 415V AC23A	A	10	
Rated conditional short-circuit current		kA	5		
Rated maximum current	gL-gG	A	16		
Rated breaking capacity	400V; cos φ=0,45	A	80		
Rated short-time withstand current (1 sec)		A	100		
Mechanical durability (thousand of operations)			1000		
Maximum connection capacity					
Rigid copper conductor		mm <sup>2</sup>	2x4		
Flexible copper conductors		mm <sup>2</sup>	2x2,5		

Approvals TP:



Approvals TB:



Approvals TF:



consult

# AC Modular switch - disconnectors and changeover switches

Modular switch – disconnectors and changeover switches of reduced size, available in different fixation types with a wide range of currents and a variety of accessories.

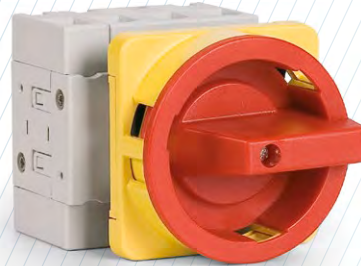

The ZBK switch - disconnectors are 3, 4, 6 and 8-pole modular devices with a high breaking capacity and contact pressure, which respond well to short circuits. They are designed for use in low voltage civil and industrial machines and facilities and made of different models depending on the type of mounting. Manufactured under strict quality controls to provide a reliable product that meets the most demanding requirements.

The ZBK series also includes a range of 1-0-2 changeover switches plus applications with plastic enclosures and various accessories.

## Range codification:

The **ZBK** series, are identified by a code that describes their most important characteristics as described below.

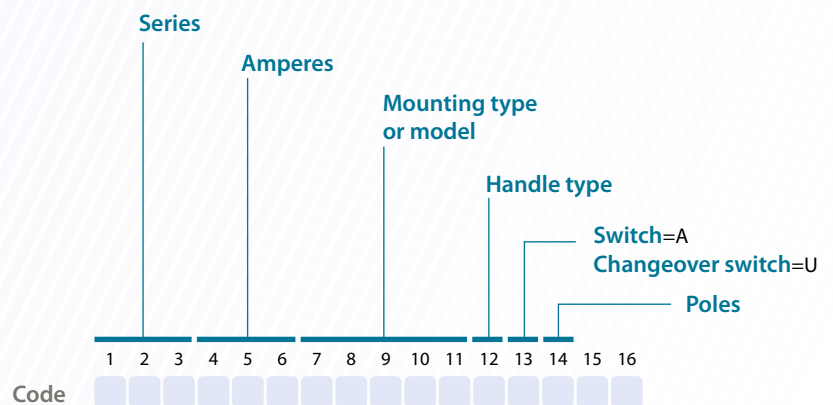

According to:  
 VDE 0660, IEC 60947-3, IEC 60947-5-1  
 UL & cUL  
 RoHS



Testing and approvals:



series  
**ZBK O-I**



Door mounting fixing by screws.  
 Two sizes of padlockable handles .  
 Auxiliary terminals and other accessories.



Base mounting fixing by screws or DIN rail and handle  $\varnothing 22$   
 Two sizes of padlockable handles .  
 Shaft extension depth-adjustable.  
 Auxiliary terminals and other accessories.

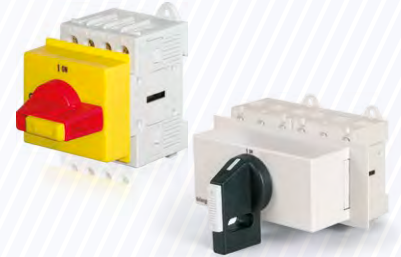

Base mounting fixing by screws or DIN rail.  
 Direct handle (modular) with lock .  
 Auxiliary terminals and other accessories.

series  
**ZBK I-O-II**



Modular switch in plastic enclosure (sealable).  
 Padlockable handles .



Base mounting fixing by screws or DIN rail.  
 Direct handle (modular) with lock .  
 Supplied with bridging links included.  
 Auxiliary terminals and other accessories.

**Accessories**



Auxiliary contacts

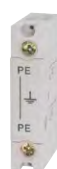

PE - Terminal



N - Terminal



N - Fixed neutral



Shaft extensions

# ZBK

## Switch door mounting with padlockable handle IP66

3P - 3P+N

Size 0

A 20|25|40|63|80|125



		CODE-20A	CODE-25A	CODE-40A	CODE-63A	CODE-80A	CODE-125A
64	3P	ZBK20EHN4A3	ZBK25EHN4A3	ZBK40EHN4A3	ZBK63EHN4A3	ZBK80EHN4A3	ZBK125EHN4A3
	3P + N	ZBK20EHN4A4	ZBK25EHN4A4	ZBK40EHN4A4	ZBK63EHN4A4	ZBK80EHN4A4	ZBK125EHN4A4
	3P	ZBK20EH4A3	ZBK25EH4A3	ZBK40EH4A3	ZBK63EH4A3	ZBK80EH4A3	ZBK125EH4A3
	3P + N	ZBK20EH4A4	ZBK25EH4A4	ZBK40EH4A4	ZBK63EH4A4	ZBK80EH4A4	ZBK125EH4A4
48	3P	ZBK20EHN1A3	ZBK25EHN1A3	ZBK40EHN1A3	ZBK63EHN1A3	ZBK80EHN1A3	-
	3P + N	ZBK20EHN1A4	ZBK25EHN1A4	ZBK40EHN1A4	ZBK63EHN1A4	ZBK80EHN1A4	-
	3P	ZBK20EH1A3	ZBK25EH1A3	ZBK40EH1A3	ZBK63EH1A3	ZBK80EH1A3	-
	3P + N	ZBK20EH1A4	ZBK25EH1A4	ZBK40EH1A4	ZBK63EH1A4	ZBK80EH1A4	-

### Technical information

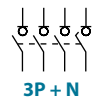

According to VDE 0660, IEC 60947-3, IEC 60947-5-1

			20	25	40	63	80	125
Rated thermal current	I <sub>th</sub>	A	20	25	40	63	80	125
Rated thermal current enclosed	I <sub>the</sub>	A	20	25	40	63	80	110
Rated insulation voltage	U <sub>i</sub>	V	690	690	690	690	690	1000
Rated impulse withstand voltage	U <sub>imp</sub>	kV	6	6	6	6	6	8
AC rated operational current	I <sub>e</sub>	AC21A	20	25	40	63	80	125
Making capacity	I <sub>eff</sub>	3x380-440V	160	190	300	370	440	850
Breaking capacity		3x220-240V	160	180	250	330	380	680
		3x380-440V	160	180	250	330	380	680
		3x660-690V	80	110	170	190	220	420
Direct switching motors	AC3	3x400V	12	16	30	37	37	72
	AC3	3x220-240V	3	4	7,5	11	11	22
		3x380-440V	5,5	7,5	15	18,5	18,5	37
		3x660-690V	5,5	7,5	15	18,5	18,5	30
Main & safety switch	AC23	3x400V	16	20	32	45	45	85
	AC23A	3x220-240V	4	5,5	9	15	15	30
	AC23B	3x380-440V	7,5	10	16	22	22	45
		3x660-690V	5,5	7,5	15	18,5	18,5	37
Rated conditional short-circuit current		kA <sub>eff</sub>	10	10	10	10	10	10
Max. fuse size	gL(gG)	A	25	35	50	63	80	125
Rated short-time withstand current (1sec.)	I <sub>cw</sub>	A	250	300	500	600	850	1500
Mechanical life		x10 <sup>3</sup>	200	200	200	100	100	100
<b>Connecting capacity</b>								
Solid or stranded cable		mm <sup>2</sup>	0,5-10			1-25 <sup>*(1)</sup>		4-50
		AWG	20-8 (10)			16-4 (10)		10-0 (10)
Flexible cable		mm <sup>2</sup>	0,5-6			4-16 <sup>*(1)</sup>		10-35
		AWG	20-10			16-6		8-2
Size of terminal screw			M3,5			M5		M6
Tightening torque		Nm	0,8-1,7			2-4		3,5-4,5

According to UL & cUL FILE NO. E123623

			20	25	40	63	80	125
Rated voltage		V	600	600	600	600	600	600
Ampere-Rating "General use"		A	20	25	40	63	80	125
DOL-Rating 3-phase	110-220V	HP	1	1,5	2	3	5	15
	220-240V	HP	3	5	5	10	10	30
	440-480V	HP	7,5	10	10	20	20	60
	550-600V	HP	10	10	15	25	25	60
DOL-Rating 1-phase	110-120V	HP	1	1	1	2	2	7,5
	200-208V	HP	1	2	2	3	3	10
	220-240V	HP	2	2	3	5	5	15
Fuse size (RK5)	Manual Motor Controller	A	40	50	70	90	110	125
	Motor Disconnect	A	40	50	50	70	70	125
Tightening torque		Nm	1,2-2,3	1,2-2,3	1,2-2,3	2,8-4	2,8-4	1,7-4,5
		lb.Inch	11-20	11-20	11-20	24-35	24-35	15-40

<sup>\*(1)</sup> ZBK63\_\_\_U stranded 16 mm<sup>2</sup> / flexible 10 mm<sup>2</sup>

Accessories

» Auxiliary contacts



1NO+1NC  
A 20 125  
CODE ZBKLNH11

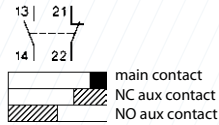

1NO+1NC overlapping  
A 20 125  
CODE ZBKLNH11X

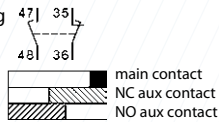

» PE - Terminal



PE | PE |  
A 20 80  
CODE ZBKPE80E

» N - Terminal



N | N1 |  
A 20 40  
CODE ZBKN40E

A 63 80  
CODE ZBKN80E

» N - Fixed neutral



N | N |  
A 20 80  
CODE ZBKPEN80E

Auxiliary contacts technical information

Rated insulation voltage	Ui	V	690
Rated thermal current	Ith - Ithe	A	10
Switching capacity	AC15	220-240V	A 2,5
	AC15	380-440V	A 1,5
Rated conditional short-circuit current		kAeff	3
Max. short circuit protection	gL(gG)	A	10

Connecting capacity

Solid or stranded cable	mm <sup>2</sup>	0,75-2,5
	AWG	14-12
Flexible cable (+ multicore cable end)	mm <sup>2</sup>	0,75-2,5 (1,5)
	AWG	18-14

Dimensions (mm)

Door drilling for external handle

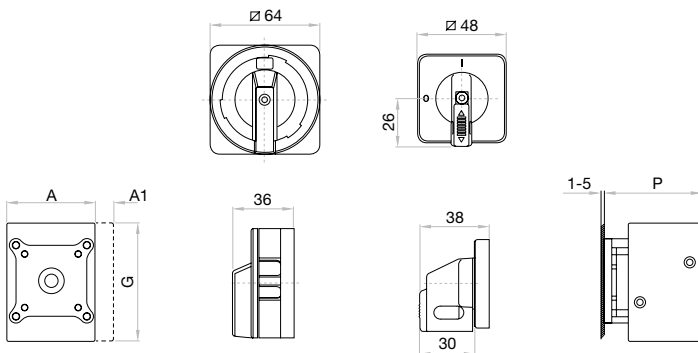
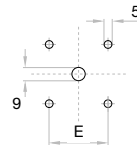

	3P		4P		
	A	A	E	G	P
20-80 A □ 48	48	62,5	36	64	54
20-80 A □ 64	48	62,5	48	64	54
125 A □ 64	78	78	48	85	60

Auxiliary contacts A1

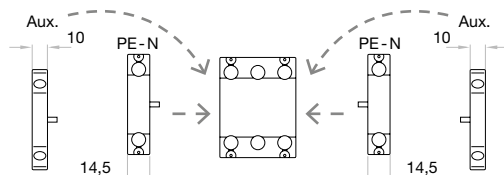

- » Other options also available on request:
  - Products external mounting fixing ø22
  - Terminal shrouds

# ZBK

## Switch base mounting $\varnothing 22$ door clutch padlockable handle IP66

Size 0

A 20|25|40|63|80|125



3P - 3P+N



		CODE-20A	CODE-25A	CODE-40A	CODE-63A	CODE-80A	CODE-125A
64	3P	ZBK20VZVHN4A3	ZBK25VZVHN4A3	ZBK40VZVHN4A3	ZBK63VZVHN4A3	ZBK80VZVHN4A3	ZBK125VZVHN4A3
	3P + N	ZBK20VZVHN4A4	ZBK25VZVHN4A4	ZBK40VZVHN4A4	ZBK63VZVHN4A4	ZBK80VZVHN4A4	ZBK125VZVHN4A4
48	3P	ZBK20VZVH4A3	ZBK25VZVH4A3	ZBK40VZVH4A3	ZBK63VZVH4A3	ZBK80VZVH4A3	ZBK125VZVH4A3
	3P + N	ZBK20VZVH4A4	ZBK25VZVH4A4	ZBK40VZVH4A4	ZBK63VZVH4A4	ZBK80VZVH4A4	ZBK125VZVH4A4
64	3P	-	ZBK25VZVHN1A3	ZBK40VZVHN1A3	ZBK63VZVHN1A3	ZBK80VZVHN1A3	ZBK125VZVHN1A3
	3P + N	-	ZBK25VZVHN1A4	ZBK40VZVHN1A4	ZBK63VZVHN1A4	ZBK80VZVHN1A4	ZBK125VZVHN1A4
48	3P	-	ZBK25VZVH1A3	ZBK40VZVH1A3	ZBK63VZVH1A3	ZBK80VZVH1A3	ZBK125VZVH1A3
	3P + N	-	ZBK25VZVH1A4	ZBK40VZVH1A4	ZBK63VZVH1A4	ZBK80VZVH1A4	ZBK125VZVH1A4

### Technical information



According to VDE 0660, IEC 60947-3, IEC 60947-5-1

			20	25	40	63	80	125
Rated thermal current	I <sub>th</sub>	A	20	25	40	63	80	125
Rated thermal current enclosed	I <sub>the</sub>	A	20	25	40	63	80	110
Rated insulation voltage	U <sub>i</sub>	V	690	690	690	690	690	1000
Rated impulse withstand voltage	U <sub>imp</sub>	kV	6	6	6	6	6	8
AC rated operational current	I <sub>e</sub>	AC21A	20	25	40	63	80	125
Making capacity	I <sub>eff</sub>	3x380-440V	160	190	300	370	440	850
Breaking capacity		3x220-240V	160	180	250	330	380	680
		3x380-440V	160	180	250	330	380	680
		3x660-690V	80	110	170	190	220	420
		3x400V	12	16	30	37	37	72
Direct switching motors	AC3	3x220-240V	3	4	7,5	11	11	22
		3x380-440V	5,5	7,5	15	18,5	18,5	37
		3x660-690V	5,5	7,5	15	18,5	18,5	30
		3x400V	16	20	32	45	45	85
Main & safety switch	AC23A	3x220-240V	4	5,5	9	15	15	30
	AC23B	3x380-440V	7,5	10	16	22	22	45
		3x660-690V	5,5	7,5	15	18,5	18,5	37
		kA <sub>eff</sub>	10	10	10	10	10	10
Rated conditional short-circuit current		kA <sub>eff</sub>	10	10	10	10	10	10
Max. fuse size	gL(gG)	A	25	35	50	63	80	125
Rated short-time withstand current (1sec.)	I <sub>cw</sub>	A	250	300	500	600	850	1500
Mechanical life		x10 <sup>3</sup>	200	200	200	100	100	100
<b>Connecting capacity</b>								
Solid or stranded cable		mm <sup>2</sup>	0,5-10			1-25 <sup>*(1)</sup>		4-50
		AWG	20-8 (10)			16-4 (10)		10-0 (10)
Flexible cable		mm <sup>2</sup>	0,5-6			4-16 <sup>*(1)</sup>		10-35
		AWG	20-10			16-6		8-2
Size of terminal screw			M3,5			M5		M6
Tightening torque		Nm	0,8-1,7			2-4		3,5-4,5

According to UL & cUL FILE NO. E123623

			20	25	40	63	80	125
Rated voltage		V	600	600	600	600	600	600
Ampere-Rating "General use"		A	20	25	40	63	80	125
DOL-Rating 3-phase		HP	1	1,5	2	3	5	15
	110-220V	HP	3	5	5	10	10	30
	220-240V	HP	7,5	10	10	20	20	60
	440-480V	HP	10	10	15	25	25	60
	550-600V	HP	1	1	1	2	2	7,5
DOL-Rating 1-phase		HP	1	2	2	3	3	10
	110-120V	HP	2	2	3	5	5	15
	200-208V	HP	40	50	70	90	110	125
	220-240V	HP	40	50	70	90	110	125
Fuse size (RK5)	Manual Motor Controller	A	40	50	70	90	110	125
	Motor Disconnect	A	40	50	70	90	110	125
Tightening torque		Nm	1,2-2,3	1,2-2,3	1,2-2,3	2,8-4	2,8-4	1,7-4,5
		lb.Inch	11-20	11-20	11-20	24-35	24-35	15-40

<sup>\*(1)</sup> ZBK63 \_\_\_U stranded 16 mm<sup>2</sup> / flexible 10 mm<sup>2</sup>

Accessories

>> Auxiliary contacts

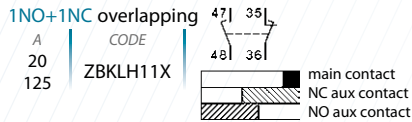
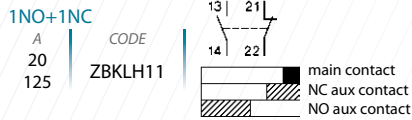

>> PE - Terminal

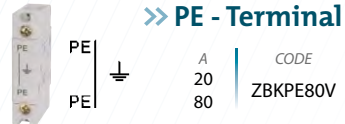

>> N - Terminal

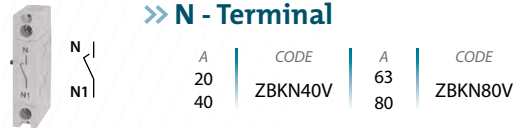

>> N - Fixed neutral

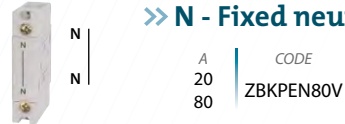

>> Shaft extensions

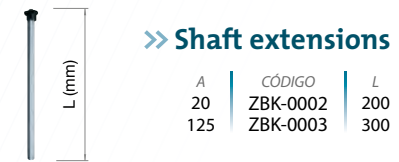

Auxiliary contacts technical information

Rated insulation voltage	Ui	V	690
Rated thermal current	Ith - Ithe	A	10
Switching capacity	AC15	220-240V	A 2,5
	AC15	380-440V	A 1,5
Rated conditional short-circuit current		kAeff	3
Max. short circuit protection	gL(gG)	A	10

Connecting capacity

Solid or stranded cable	mm <sup>2</sup>	0,75-2,5
	AWG	14-12
Flexible cable (+ multicore cable end)	mm <sup>2</sup>	0,75-2,5 (1,5)
	AWG	18-14

Dimensions (mm)

Door drilling for external handle

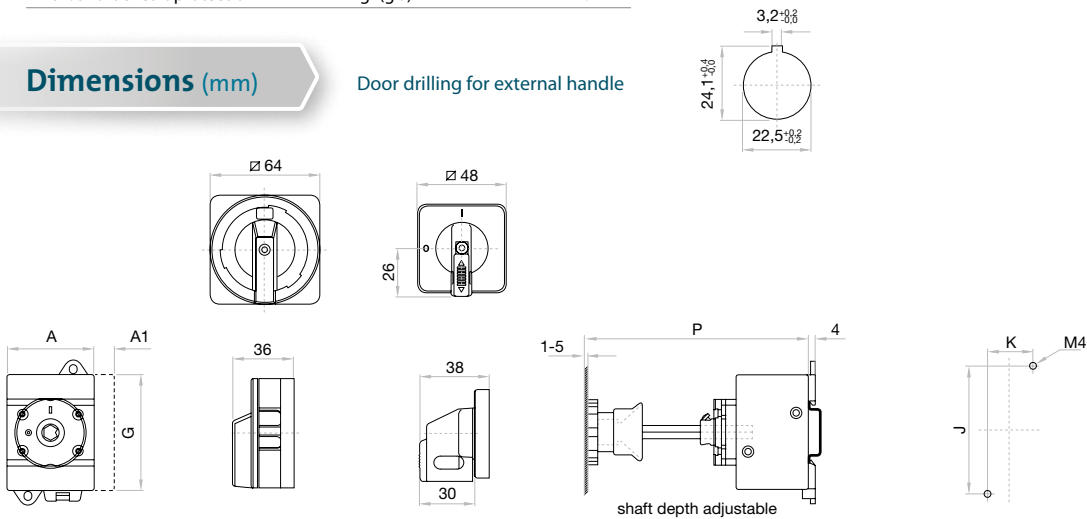

Auxiliary contacts A1

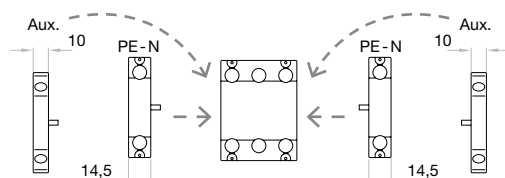

A	3P		4P		P	
	A	A	G	J	K	min max
20 - 40 A	48	48	64	70	25	91 190
63 - 80 A	48	62,5	64	70	25	91 190
125 A	78	78	85	90	38	95 190

- >> Other options also available on request:
  - Products with customized shaft dimensions (L max = 400mm)
  - Terminal shrouds

# ZBK

## Switch base mounting $\varnothing 22$ door clutch padlockable handle IP66

6P - 8P

Size 0

A 25|40|80



	CODE - 25A	CODE - 40A	CODE - 80A
6P	ZBK25VZVHN4A6	ZBK40VZVHN4A6	ZBK80VZVHN4A6
8P	ZBK25VZVHN4A8	ZBK40VZVHN4A8	ZBK80VZVHN4A8
6P	ZBK25VZVH4A6	ZBK40VZVH4A6	ZBK80VZVH4A6
8P	ZBK25VZVH4A8	ZBK40VZVH4A8	ZBK80VZVH4A8

### Technical information

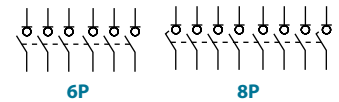

According to VDE 0660, IEC 60947-3, IEC 60947-5-1

			25	40	80
Rated thermal current	I <sub>th</sub>	A	25	40	80
Rated thermal current enclosed	I <sub>the</sub>	A	25	40	80
Rated insulation voltage	U <sub>i</sub>	V	690	690	690
Rated impulse withstand voltage	U <sub>imp</sub>	kV	6	6	6
AC rated operational current	I <sub>e</sub>	AC21A	A	40	80
Making capacity	I <sub>eff</sub>	3x380-440V	A	190	300
Breaking capacity		3x220-240V	A	180	250
		3x380-440V	A	180	250
		3x660-690V	A	110	170
Direct switching motors	AC3	3x400V	A	16	30
	AC3	3x220-240V	kW	4	7,5
		3x380-440V	kW	7,5	15
		3x660-690V	kW	7,5	15
Main & safety switch	AC23	3x400V	A	20	32
	AC23A	3x220-240V	kW	5,5	9
	AC23B	3x380-440V	kW	10	16
		3x660-690V	kW	7,5	15
Rated conditional short-circuit current		kA <sub>eff</sub>	10	10	10
Max. fuse size	gL(gG)	A	35	50	80
Rated short-time withstand current (1sec.)	I <sub>cw</sub>	A	300	500	850
Mechanical life		x10 <sup>3</sup>	200	200	100
<b>Connecting capacity</b>					
Solid or stranded cable		mm <sup>2</sup>	0,5-10		1-25
		AWG	20-8 (10)		16-4 (10)
Flexible cable		mm <sup>2</sup>	0,5-6		4-16
		AWG	20-10		16-6
Size of terminal screw			M3,5		M5
Tightening torque		Nm	0,8-1,7		2-4

According to UL & cUL FILE NO. E123623

			25	40	80
Rated voltage		V	600	600	600
Ampere-Rating "General use"		A	25	40	80
DOL-Rating 3-phase		110-220V	HP	1,5	5
		220-240V	HP	5	10
		440-480V	HP	10	20
		550-600V	HP	10	15
		110-120V	HP	1	2
DOL-Rating 1-phase		200-208V	HP	2	3
		220-240V	HP	2	3
					5
Fuse size (RK5)	Manual Motor Controller	A	50	70	110
	Motor Disconnect	A	50	50	70
Tightening torque		Nm	1,2-2,3	1,2-2,3	2,8-4
		lb.Inch	11-20	11-20	24-35

Accessories

» Auxiliary contacts



1NO+1NC	CODE
A	ZBKLH11
25	
80	

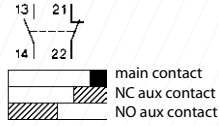

1NO+1NC overlapping	CODE
A	ZBKLH11X
25	
80	

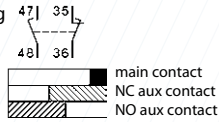

» PE - Terminal



PE	A	CODE
PE	25	ZBKPE80V
PE	80	

» N - Terminal

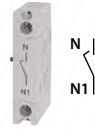

N	A	CODE	A	CODE
N1	25	ZBKN40V	80	ZBKN80V
	40			

» N - Fixed neutral



N	A	CODE
N	25	ZBKPEN80V
	80	

» Shaft extensions



A	CÓDIGO	L
20	ZBK-0002	200
125	ZBK-0003	300

Auxiliary contacts technical information

Rated insulation voltage	Ui	V	690	
Rated thermal current	Ith - Ithe	A	10	
Switching capacity	AC15	220-240V	A	2,5
	AC15	380-440V	A	1,5
Rated conditional short-circuit current		kAeff	3	
Max. short circuit protection	gL(gG)	A	10	

Connecting capacity

Solid or stranded cable	mm <sup>2</sup>	0,75-2,5
	AWG	14-12
Flexible cable (+ multicore cable end)	mm <sup>2</sup>	0,75-2,5 (1,5)
	AWG	18-14

Dimensions (mm)

Door drilling for external handle

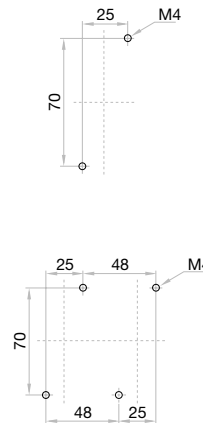
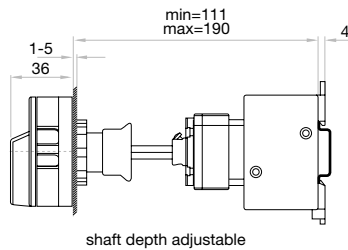
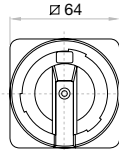
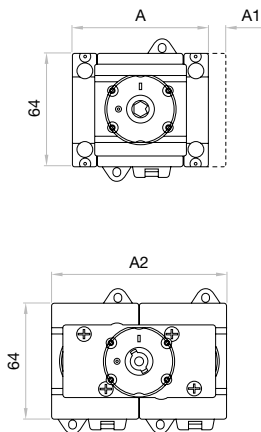
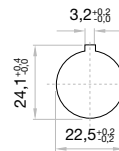

	6P	6P	8P
	A	A2	A2
25 - 40 A	77	-	97
80 A	-	97	126

Auxiliary contacts A1

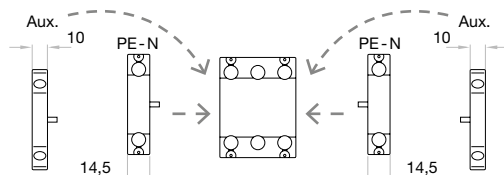

- » Other options also available on request:
- Products with customized shaft dimensions (L max=400mm)
  - Terminal shrouds

# ZBK

## Switch & changeover

### DIN rail mounting modular padlockable handle IP40 3P - 3P+N - 6P - 8P

Size 0

A 20|25|40|63|80|125



		CODE-20A	CODE-25A	CODE-40A	CODE-63A	CODE-80A	CODE-125A
Switch	3P	ZBK20SMAHN1A3	ZBK25SMAHN1A3	ZBK40SMAHN1A3	ZBK63SMAHN1A3	ZBK80SMAHN1A3	ZBK125SMAHN1A3
	3P + N	ZBK20SMAHN1A4	ZBK25SMAHN1A4	ZBK40SMAHN1A4	ZBK63SMAHN1A4	ZBK80SMAHN1A4	ZBK125SMAHN1A4
	3P	ZBK20SMAH1A3	ZBK25SMAH1A3	ZBK40SMAH1A3	ZBK63SMAH1A3	ZBK80SMAH1A3	ZBK125SMAH1A3
	3P + N	ZBK20SMAH1A4	ZBK25SMAH1A4	ZBK40SMAH1A4	ZBK63SMAH1A4	ZBK80SMAH1A4	ZBK125SMAH1A4
	6P	-	ZBK25SMAHN1A6	ZBK40SMAHN1A6	-	ZBK80SMAHN1A6	-
	8P	-	ZBK25SMAHN1A8	ZBK40SMAHN1A8	-	ZBK80SMAHN1A8	-
Changeover	6P	-	ZBK25SMAH1A6	ZBK40SMAH1A6	-	ZBK80SMAH1A6	-
	8P	-	ZBK25SMAH1A8	ZBK40SMAH1A8	-	ZBK80SMAH1A8	-
	3P + N	ZBK20SMAH1U4	ZBK25SMAH1U4	ZBK40SMAH1U4	ZBK63SMAH1U4	-	-

### Technical information

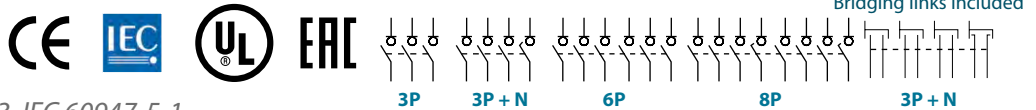

According to VDE 0660, IEC 60947-3, IEC 60947-5-1

			20	25	40	63	80	125	
Rated thermal current	I <sub>th</sub>	A	20	25	40	63	80	125	
Rated thermal current enclosed	I <sub>the</sub>	A	20	25	40	63	80	110	
Rated insulation voltage	U <sub>i</sub>	V	690	690	690	690	690	1000	
Rated impulse withstand voltage	U <sub>imp</sub>	kV	6	6	6	6	6	8	
AC rated operational current	I <sub>e</sub>	A	20	25	40	63	80	125	
Making capacity	I <sub>eff</sub>	AC21A	3x380-440V	A	160	190	300	370	440
Breaking capacity		3x220-240V	A	160	180	250	330	380	680
		3x380-440V	A	160	180	250	330	380	680
		3x660-690V	A	80	110	170	190	220	420
Direct switching motors	AC3	3x400V	A	12	16	30	37	37	72
	AC3	3x220-240V	kW	3	4	7,5	11	11	22
		3x380-440V	kW	5,5	7,5	15	18,5	18,5	37
		3x660-690V	kW	5,5	7,5	15	18,5	18,5	30
		3x400V	A	16	20	32	45	45	85
Main & safety switch	AC23A	3x220-240V	kW	4	5,5	9	15	15	30
	AC23B	3x380-440V	kW	7,5	10	16	22	22	45
		3x660-690V	kW	5,5	7,5	15	18,5	18,5	37
		3x400V	A	16	20	32	45	45	85
Rated conditional short-circuit current		kA <sub>eff</sub>	10	10	10	10	10	10	
Max. fuse size	gL(gG)	A	25	35	50	63	80	125	
Rated short-time withstand current (1sec.)	I <sub>cw</sub>	A	250	300	500	600	850	1500	
Mechanical life		x10 <sup>3</sup>	200	200	200	100	100	100	

Connecting capacity			20	25	40	63	80	125
Solid or stranded cable		mm <sup>2</sup>		0,5-10		1-25 <sup>*(1)</sup>		4-50
		AWG		20-8 (10)		16-4 (10)		10-0 (10)
Flexible cable		mm <sup>2</sup>		0,5-6		4-16 <sup>*(1)</sup>		10-35
		AWG		20-10		16-6		8-2
Size of terminal screw				M3,5		M5		M6
Tightening torque		Nm		0,8-1,7		2-4		3,5-4,5

According to UL & cUL FILE NO. E123623

			20	25	40	63	80	125
Rated voltage		V	600	600	600	600	600	600
Ampere-Rating "General use"		A	20	25	40	63	80	125
DOL-Rating 3-phase	110-220V	HP	1	1,5	2	3	5	15
	220-240V	HP	3	5	5	10	10	30
	440-480V	HP	7,5	10	10	20	20	60
	550-600V	HP	10	10	15	25	25	60
	200-208V	HP	1	1	1	2	2	7,5
DOL-Rating 1-phase	110-120V	HP	1	1	1	2	2	7,5
	200-208V	HP	1	2	2	3	3	10
	220-240V	HP	2	2	3	5	5	15
Fuse size (RK5)	Manual Motor Controller	A	40	50	70	90	110	125
5kA / 600V	Motor Disconnect	A	40	50	50	70	70	125
Tightening torque		Nm	1,2-2,3	1,2-2,3	1,2-2,3	2,8-4	2,8-4	1,7-4,5
		lb.Inch	11-20	11-20	11-20	24-35	24-35	15-40

\*1) ZBK63 \_\_\_U stranded 16 mm<sup>2</sup> / flexible 10 mm<sup>2</sup>

Accessories

» Auxiliary contacts



1NO+1NC  
A 20 125  
CODE ZBK LH11

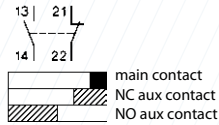

1NO+1NC overlapping  
A 20 125  
CODE ZBK LH11X

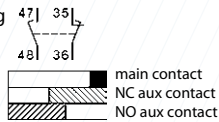

» PE - Terminal



A 20 80  
CODE ZBK PE80V

» N - Fixed neutral



A 20 80  
CODE ZBK PEN80V

Auxiliary contacts technical information

Rated insulation voltage	Ui	V	690
Rated thermal current	lth - lthe	A	10
	AC15	220-240V	A 2,5
Switching capacity	AC15	380-440V	A 1,5
	Rated conditional short-circuit current	kAeff	3
Max. short circuit protection	gL(gG)	A	10

Connecting capacity

Solid or stranded cable	mm <sup>2</sup>	0,75-2,5
	AWG	14-12
Flexible cable (+ multicore cable end)	mm <sup>2</sup>	0,75-2,5 (1,5)
	AWG	18-14

Dimensions (mm)

Switch

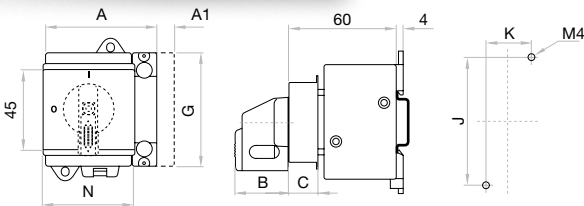

3P-4P 20-125A

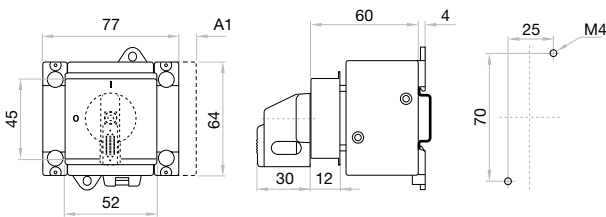

6P 25-40A

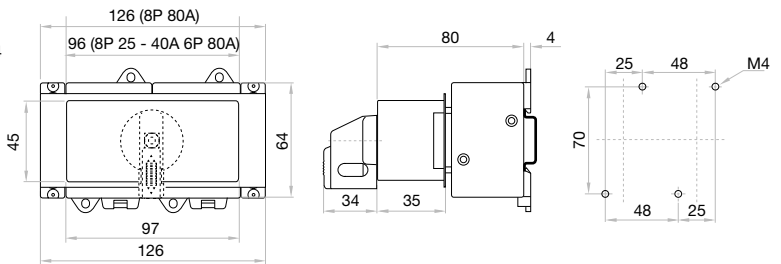

8P 25-40A  
6P-8P 80A

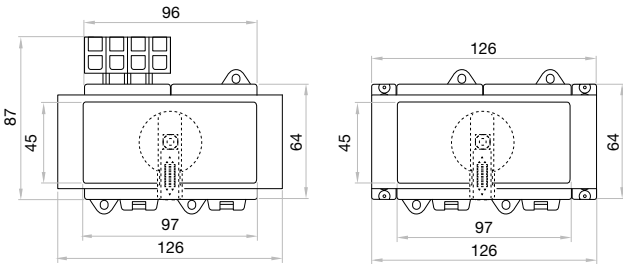

20-40A

63A

Auxiliary contacts A1

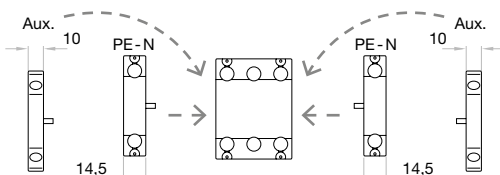

- » Other options also available on request:
  - Terminal shrouds
  - 3P changeovers

**ZBK**

# Switch plastic enclosure padlockable handle IP66 3P - 3P+N - 6P - 8P

Size 0

A 20|25|40|63|80|125



series  
**ZBK**

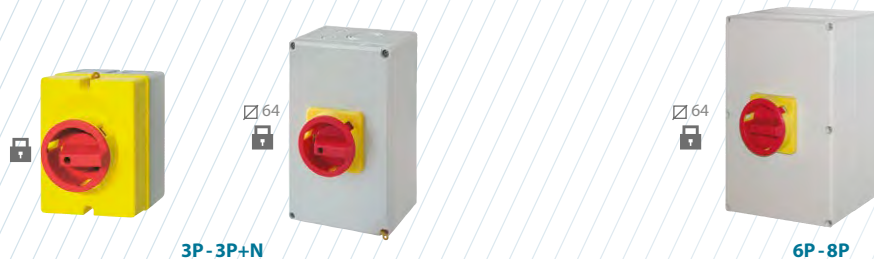

	CODE-20A	CODE-25A	CODE-40A	CODE-63A	CODE-80A	CODE-125A
3P	ZBK20PFHN4A3	ZBK25PFHN4A3	ZBK40PFHN4A3	ZBK63PFLHN4A3	ZBK80PFLHN4A3	ZBK125PFLHN4A3
3P + N	ZBK20PFHN4A4	ZBK25PFHN4A4	ZBK40PFHN4A4	ZBK63PFLHN4A4	ZBK80PFLHN4A4	ZBK125PFLHN4A4
6P	-	ZBK25PFLHN4A6	ZBK40PFLHN4A6	-	ZBK80PFLHN4A6	-
8P	-	ZBK25PFLHN4A8	ZBK40PFLHN4A8	-	ZBK80PFLHN4A8	-

## Technical information

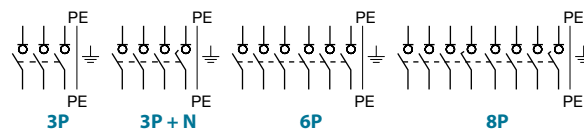

According to VDE 0660, IEC 60947-3, IEC 60947-5-1

			20	25	40	63	80	125
Rated thermal current	I <sub>th</sub>	A	20	25	40	63	80	125
Rated thermal current enclosed	I <sub>the</sub>	A	20	25	40	63	80	110
Rated insulation voltage	U <sub>i</sub>	V	690	690	690	690	690	1000
Rated impulse withstand voltage	U <sub>imp</sub>	kV	6	6	6	6	6	8
AC rated operational current	I <sub>e</sub>	AC21A	20	25	40	63	80	125
Making capacity	I <sub>eff</sub>	3x380-440V	160	190	300	370	440	850
Breaking capacity		3x220-240V	160	180	250	330	380	680
		3x380-440V	160	180	250	330	380	680
		3x660-690V	80	110	170	190	220	420
		3x400V	12	16	30	37	37	72
Direct switching motors	AC3	3x220-240V	3	4	7,5	11	11	22
		3x380-440V	5,5	7,5	15	18,5	18,5	37
		3x660-690V	5,5	7,5	15	18,5	18,5	30
		3x400V	16	20	32	45	45	85
Main & safety switch	AC23A	3x220-240V	4	5,5	9	15	15	30
	AC23B	3x380-440V	7,5	10	16	22	22	45
		3x660-690V	5,5	7,5	15	18,5	18,5	37
		kA <sub>eff</sub>	10	10	10	10	10	10
Rated conditional short-circuit current		kA <sub>eff</sub>	10	10	10	10	10	10
Max. fuse size	gLG(gG)	A	25	35	50	63	80	125
Rated short-time withstand current (1sec.)	I <sub>cw</sub>	A	250	300	500	600	850	1500
Mechanical life		x10 <sup>3</sup>	200	200	200	100	100	100
<b>Connecting capacity</b>								
Solid or stranded cable		mm <sup>2</sup>	0,5-10			1-25 <sup>*(1)</sup>		4-50
		AWG	20-8 (10)			16-4 (10)		10-0 (10)
Flexible cable		mm <sup>2</sup>	0,5-6			4-16 <sup>*(1)</sup>		10-35
		AWG	20-10			16-6		8-2
Size of terminal screw			M3,5			M5		M6
Tightening torque		Nm	0,8-1,7			2-4		3,5-4,5

According to UL & cUL FILE NO. E123623

			20	25	40	63	80	125
Rated voltage		V	600	600	600	600	600	600
Ampere-Rating "General use"		A	20	25	40	63	80	125
DOL-Rating 3-phase		110-220V	HP	1	1,5	2	3	5
		220-240V	HP	3	5	5	10	10
		440-480V	HP	7,5	10	10	20	20
		550-600V	HP	10	10	15	25	25
		110-120V	HP	1	1	1	2	2
DOL-Rating 1-phase		200-208V	HP	1	2	2	3	3
		220-240V	HP	2	2	3	5	5
		5kA / 600V	Manual Motor Controller	A	40	50	70	90
		5kA / 600V	Motor Disconnect	A	40	50	50	70
Tightening torque		Nm	1,2-2,3	1,2-2,3	1,2-2,3	2,8-4	2,8-4	
		lb.Inch	11-20	11-20	11-20	24-35	24-35	

<sup>\*(1)</sup> ZBK63\_\_\_U stranded 16 mm<sup>2</sup> / flexible 10 mm<sup>2</sup>

Accessories



>> Auxiliary contacts <sup>\*(a1)</sup>

1NO+1NC  
A 20  
125  
CODE  
ZBKLH11

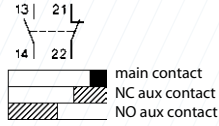

>> Auxiliary contacts <sup>\*(a1)</sup>

1NO+1NC overlapping  
A 20  
125  
CODE  
ZBKLH11X

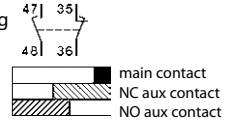

Auxiliary contacts technical information

Rated insulation voltage	Ui	V	690
Rated thermal current	Ith - Ithe	A	10
Switching capacity	AC15	220-240V	A 2,5
	AC15	380-440V	A 1,5
Rated conditional short-circuit current		kAeff	3
Max. short circuit protection	gL(gG)	A	10

Connecting capacity

Solid or stranded cable	mm <sup>2</sup>	0,75-2,5
	AWG	14-12
Flexible cable (+ multicore cable end)	mm <sup>2</sup>	0,75-2,5 (1,5)
	AWG	18-14

Dimensions (mm)

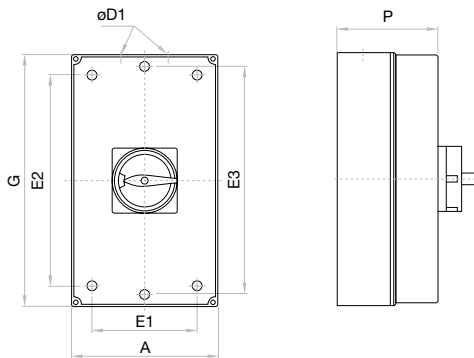

	A	D1	E1	E2	E3	G	P
20 - 40 A	3/4P	98	2 x 25,5/20,5/16,5/12,5	75	150	170	76
63 - 125 A	3/4P	140	40,5/32,5 + 16,5 + 12,5	100	160	188,5	86
25 - 40 A	6P	140	40,5/32,5 + 16,5 + 12,5	100	160	188,5	86
25 - 40 A	8P	176	2x40,5 / 32,5	120	200	228,5	120
80 A	6/8P	176	2x40,5 / 32,5	120	200	228,5	120

Auxiliary contacts <sup>\*(a1)</sup>

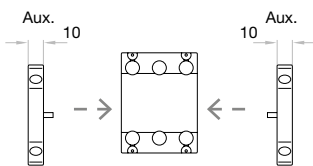

<sup>\*(a1)</sup> Standard enclosure capacity swit + 1 aux.  
For other needs please consult.

- >> Other options also available on request:
- Changeovers
  - Black/grey handle